

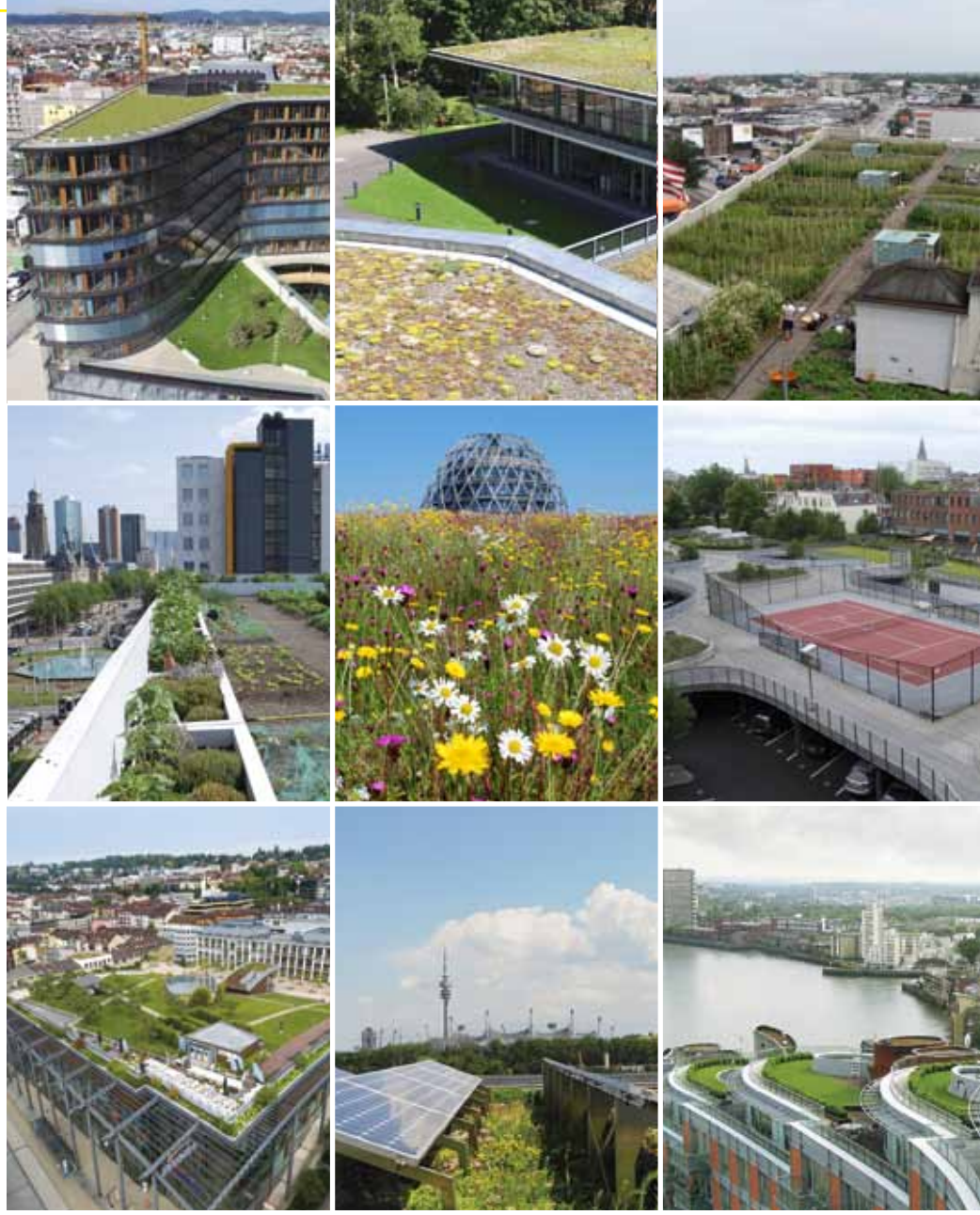

LandscapeDevelopment  
and Landscaping  
Research Society e.V.



**– Green Roof Guidelines –  
Guidelines for the Planning,  
Construction and Maintenance  
of Green Roofs**

**2018 edition**

**The following organisations have assisted FLL in developing the 'Green Roof Guidelines'**



**Arbeitsgemeinschaft Sachverständige Gartenbau – Landschaftsbau– Sportplatzbau e.V. (AGS)**  
Hanauer Straße 409, D-63075 Offenbach  
Tel.: +49 (0) 69 838324-0, Fax: +49 (0) 69 868057  
E-Mail: info@ag-sachverstaendige.de, Homepage: www.ag-sachverstaendige.de



**Bund Deutscher Landschaftsarchitekten e. V. (bdla)**  
Köpenicker Straße 48/49, D-10179 Berlin  
Tel.: +49 (0) 30 / 278715-0, Fax: +49 (0) 30 / 278715-55  
E-Mail: info@bdla.de, Homepage: www.bdla.de



**Bundesverband Garten-, Landschafts- und Sportplatzbau e. V. (BGL)**  
Alexander-von-Humboldt-Straße 4, D-53604 Bad Honnef  
Tel.: +49 (0) 2224 / 7707-0, Fax: +49 (0) 2224 / 7707-77  
E-Mail: webmaster@galabau.de, Homepage: www.galabau.de



**Bundesverband Gebäude Grün e.V. (BuGG)**  
Albrechtstraße 13, D-10117 Berlin  
Tel.: +49 (0) 30 / 400 54 102  
E-Mail: info@bugg.de, Homepage: www.bugg.de, www.gebaeudegruen.info



**Note:** In may 2018 DDV and FFB have merged into BuGG.



**Deutsche Gartenamtsleiterkonferenz (GALK<sup>e.V.</sup>)**  
Geschäftsstelle der GALK  
Adam-Riese-Straße 25, D-60327 Frankfurt am Main  
Tel.: +49 (0) 069 / 212 – 30304  
E-Mail: geschaeftsstelle@galk.de, Homepage: www.galk.de



**Europäischer Fachverband für Erosionsschutz und Begrünung e. V. (EFEB)**  
Vor der Lake 14, D-57392 Schmallenberg  
Tel.: +49 (0) 29 72 - 9 62 06 – 0, Fax: +49 (0) 29 72 - 9 62 06 - 19  
E-Mail: info@efeb.org, Homepage: www.efeb.org



**Gütegemeinschaft Substrate für Pflanzen e. V. (GGS)**  
Wunstorfer Landstrasse 8, D-30453 Hannover  
Tel.: +49 (0) 511 / 48189388, Fax: +49 (0) 511 / 4818287  
E-Mail: info@substrate-ev.org, Homepage: www.substrate-ev.org



**Industrieverband Bitumen-Dach- und Dichtungsbahnen e.V. (vdd)**  
Mainzer Landstraße 55, 60329, D-Frankfurt am Main  
Tel.: 069/2556-1315, Fax: 069/2556-1602  
E-Mail: info@derdichtebau.de, Homepage: www.derdichtebau.de



**Verband der Begrünungs-System Hersteller e. V. (VBSh)**  
Heinrich-Hertz-Straße 1a, D-59423 Unna  
Tel.: +49 (0) 2303 / 25002-0, Fax: +49 (0) 2303 / 25002-33  
E-Mail: info@vbsh-ev.de, Homepage: www.vbsh-ev.de



**Zentralverband Gartenbau (ZVG) e. V.**  
Claire-Waldoff-Straße 7, D-10117 Berlin  
Tel.: +49 (0) 30 / 2000 65-19, Fax: +49 (0) 30 / 2000 65-21  
E-Mail: info@g-net.de, Homepage: www.g-net.de



**Zentralverband des Deutschen Dachdeckerhandwerks e. V. (ZVDH)**  
Fachverband Dach-, Wand- und Abdichtungstechnik  
Fritz-Reuter-Str. 1, D-50968 Köln, Postfach 51 10 67, 50946 Köln  
Tel.: +49 (0)221 3980 38–0, Fax: +49 (0)221 398038–99  
E-Mail: zvdh@dachdecker.de, Homepage: www.dachdecker.org

**– Green Roof Guidelines –  
Guidelines for the Planning, Construction  
and Maintenance of Green Roofs**

2018 edition

Prepared by the editorial board and working group “Dachbegrünungen”

with

**Investigation methods for growing media and drainage layer bulk  
materials for green roofs**

2018 Edition

and

**Method for investigating the root resistance of membranes and  
coatings for green roofs**

1999 edition, with editorial changes 2002/2008 as well as  
supplementary notes to "Requirements for transcription / renewal of test certificates"  
(adopted and implemented by the FLL presidium at the end of 2016)

**Notes for the user**

Any interested party may freely use the technical regulations issued by the FLL. An obligation to apply these guidelines may arise from any legal, administrative or contractual regulation or from any other legal requirements.

FLL guidelines are the result of voluntary technical and scientific cooperative work. The principles and rules applied when establishing these guidelines mean they can be considered technically correct.

FLL guidelines are an important source of expertise for professional behavior in standard working situations. However, they cannot include all special cases for which additional or restrictive measures may be required. Nevertheless, they present a benchmark for faultless technical behavior. This benchmark is also significant in the context of the law.

FLL guidelines are intended to be established as a “recognized code of practice”.

Using the FLL guidelines does not diminish the user’s responsibility for their own actions. Everyone is liable for his or her own actions. Everyone acts at his or her own risk.

Anyone who identifies a mistake or ambiguity, which may lead to a wrong application of these guidelines, is requested to report it immediately to the FLL to ensure any flaws can be eliminated. Modal auxiliary verbs (e.g. shall, should, must) and their meanings are of particular significance to gain a clear understanding of the regulations. See information in DIN 820 “Standardization”.

## **– Green Roof Guidelines – Guidelines for the planning, construction and maintenance of green roofs**

### **Publisher:**

Landscape Development and Landscaping Research Society e.V. (FLL)  
Friedensplatz 4, 53111 Bonn  
Tel.: + 49 228/965010-0, Fax: + 49 228/965010-20  
E-Mail: info@fll.de, Homepage: www.fll.de

### **Compiled by the Editorial Board (EB) “Green roofs”:**

Prof. Gilbert Lösken (EB-Director), Hannover  
Wolfgang Ansel (Deutscher Dachgärtner Verband e.V., nun Bundesverband GebäudeGrün e. V. BuGG),  
Nürtingen/Berlin  
Tobias Backhaus (Zentralverband des Deutschen Dachdeckerhandwerks e. V.), Köln  
Prof. Dr. Yvonne-Christin Bartel, Höxter  
Dr. Hanna Bornholdt (Deutsche Gartenamtsleiterkonferenz), Hamburg  
Peter Bott (Verband der Begrünungs-Systemhersteller e. V.), Bühl  
Dr. Michael Henze (Bundesverband Garten-, Landschafts- und Sportplatzbau e. V.), Bad Honnef  
Jakob Hokema (Zentralverband Gartenbau e. V.), Schwäbisch-Gmünd/Lindach  
Prof. Dr. Manfred Köhler, Neubrandenburg  
Bernd W. Krupka, Bad Pyrmont  
Dr. Gunter Mann (Fachvereinigung Bauwerksbegrünung e. V., nun Bundesverband GebäudeGrün e. V.  
BuGG), Saarbrücken/Berlin  
Marko Münster (Arbeitsgemeinschaft Sachverständige Gartenbau – Landschaftsbau– Sportplatzbau e.V.),  
Berglen  
Holger Neisser (Europäischer Fachverband für Erosionsschutz und Begrünung e.V.), Schmallenberg  
Prof. Dr. Stephan Roth-Kleyer, Geisenheim  
Stefan Ruttensperger (Industrieverband Bitumen-, Dach- und Dichtungsbahnen e. V.), Stuttgart  
Dieter Schenk, Nürtingen  
Daniel Sprenger (Bund Deutscher Landschaftsarchitekten e. V.), Berlin  
Dr. Martin Upmeier (Gütegemeinschaft Substrate für Pflanzen e. V.), Hannover  
Daniel Westerholt, Hannover

### **Consultation in Working Group “Dachbegrünungen”**

Roland Appl, Nürtingen	Peter König, Kretz
Rainer Bohlen, Ladbergen	Peter Küsters, Krauchenwies-Göggingen
Jochen Boich, Wuppertal	Prof. Dr. Nicole Pfoser, Darmstadt
Markus Boley, Brühl	Dr. Christian Schade, Groß Ippener
Dr. Rainer Henseleit, Frankfurt/Main	Nicole Vogt, Saarbrücken
Dr. Michael Marrett-Foßen, Hamburg	Ulrike Wegener, Hannover
Ralph Klein, Rodenbach	Holger Zühlke, Unna

### **Consultant:**

Anette Sixter, Geisenheim

### **Contact person in the office as well as text and cover design:**

Christian Schulze-Ardey, Landscape Architect AK NW, FLL, Bonn

**Drawings/illustrations:** Prof. Dr. Yvonne-Christin Bartel, Martin Jauch (✚)

**Cover image/images:** Dr. Gunter Mann, Saarbrücken und Dieter Schenk, Nürtingen

All rights reserved.

This document may only be reproduced in its entirety and only after express prior consent from the publisher. Distribution via the publisher.

Printed on chlorine-free paper.

6<sup>th</sup> Edition, 2.000 copies, Bonn, 2018

Previous Editions: Grundsätze für Dachbegrünungen 1982, 1984

From 1990 Richtlinien für Dachbegrünungen: 1990, 1992, 1995, 2002, 2008

---

# Content

---

<b>Index of Figures and Tables .....</b>	<b>9</b>
<b>Preface .....</b>	<b>11</b>
<b>1 Scope, Purpose .....</b>	<b>12</b>
<b>1.1 Scope .....</b>	<b>12</b>
<b>1.2 Purpose .....</b>	<b>12</b>
<b>2 Normative References .....</b>	<b>13</b>
<b>3 Definitions .....</b>	<b>17</b>
<b>4 Legal Framework Conditions .....</b>	<b>20</b>
<b>4.1 Construction planning law.....</b>	<b>20</b>
<b>4.2 Building regulations .....</b>	<b>20</b>
<b>4.3 Preservation .....</b>	<b>20</b>
<b>4.4 Conservation .....</b>	<b>20</b>
<b>4.5 Wastewater law .....</b>	<b>20</b>
<b>5 Types of Green Roof and Forms of Vegetation.....</b>	<b>21</b>
<b>5.1 Types of green roof.....</b>	<b>21</b>
5.1.1 General information.....	21
5.1.2 Intensive green roofs.....	21
5.1.3 Simple intensive green roofs .....	21
5.1.4 Extensive green roofs.....	22
<b>5.2 Forms of vegetation.....</b>	<b>22</b>
5.2.1 General .....	22
5.2.2 Vegetation forms of intensive green roofs .....	22
5.2.2.1 Kitchen gardens .....	23
5.2.2.2 Greening with turfs .....	23
5.2.3 Vegetation forms of simple intensive greening .....	23
5.2.4 Vegetation forms of extensive greening.....	23
<b>5.3 Determination of site conditions for vegetation .....</b>	<b>24</b>
5.3.1 General .....	24
5.3.2 Climate and weather-dependent factors.....	24
5.3.3 Structure-dependent factors .....	24
5.3.4 Plant specific factors .....	25
<b>6 Function and effects .....</b>	<b>26</b>
<b>6.1 General.....</b>	<b>26</b>
<b>6.2 Urban and open space planning functions and effects .....</b>	<b>26</b>
<b>6.3 Ecological functions and effects .....</b>	<b>27</b>
<b>6.4 Protective and economic functions and effects .....</b>	<b>27</b>
<b>7 Requirements for construction and building materials.....</b>	<b>28</b>

<b>7.1</b>	<b>Planning Requirements</b> .....	<b>28</b>
<b>7.2</b>	<b>Type of use/usability</b> .....	<b>28</b>
<b>7.3</b>	<b>Roof pitch/fall</b> .....	<b>29</b>
<b>7.4</b>	<b>Roof construction and effective greening</b> .....	<b>30</b>
7.4.1	Roofs with waterproofing .....	30
7.4.2	Roofs made from waterproof concrete (“WP-Concrete”).....	31
7.4.3	Roofs with decking .....	31
<b>7.5</b>	<b>Vapor diffusion</b> .....	<b>31</b>
<b>7.6</b>	<b>Load assumptions</b> .....	<b>31</b>
<b>7.7</b>	<b>Protection against falling</b> .....	<b>32</b>
<b>7.8</b>	<b>Drainage</b> .....	<b>32</b>
<b>7.9</b>	<b>Irrigation</b> .....	<b>33</b>
<b>7.10</b>	<b>Materials</b> .....	<b>34</b>
<b>7.11</b>	<b>Environmental compatibility</b> .....	<b>34</b>
<b>7.12</b>	<b>Plant compatibility/phytotoxic safety</b> .....	<b>34</b>
<b>8</b>	<b>Structural Requirements</b> .....	<b>35</b>
<b>8.1</b>	<b>General information</b> .....	<b>35</b>
<b>8.2</b>	<b>Root barrier</b> .....	<b>35</b>
8.2.1	Materials .....	35
8.2.2	Requirements.....	36
8.2.3	Implementation.....	36
<b>8.3</b>	<b>Protection against damage to the waterproofing/root barrier membrane</b> .....	<b>37</b>
8.3.1	Materials .....	37
8.3.2	Requirements.....	37
8.3.3	Implementation.....	38
<b>8.4</b>	<b>Protection against efflorescence</b> .....	<b>39</b>
<b>8.5</b>	<b>Drainage facilities</b> .....	<b>39</b>
8.5.1	Types .....	39
8.5.2	Requirements.....	39
8.5.3	Implementation.....	40
8.5.3.1	Roof drains in vegetation areas .....	40
8.5.3.2	Roof drains outside vegetation areas .....	40
8.5.3.3	Emergency overflows .....	40
8.5.3.4	Drainage on sloping roofs .....	40
<b>8.6</b>	<b>Transition points</b> .....	<b>41</b>
8.6.1	Types .....	41
8.6.2	Requirements.....	41
8.6.2.1	Transition heights.....	41
8.6.2.2	Marginal strips.....	42

8.6.3	Implementation.....	42
8.6.3.1	Transitions to rising structural elements .....	42
8.6.3.2	Transitions to doors with barrier-free transitions .....	43
8.6.3.3	Roof edging.....	43
<b>8.7</b>	<b>Protection against emissions .....</b>	<b>43</b>
<b>8.8</b>	<b>Protection against negative wind pressure .....</b>	<b>43</b>
<b>8.9</b>	<b>Fire prevention measures .....</b>	<b>44</b>
<b>8.10</b>	<b>Protection against material displacement.....</b>	<b>46</b>
8.10.1	Types .....	46
8.10.1.1	Surface erosion .....	46
8.10.1.2	Slipping of layers at a layer boundary.....	47
8.10.1.3	Material displacement when the bulk angle of repose is exceeded.....	47
8.10.2	Material properties .....	48
8.10.3	Manufacture .....	49
<b>8.11</b>	<b>Edging .....</b>	<b>51</b>
8.11.1	Types .....	51
8.11.2	Requirements.....	51
8.11.3	Implementation.....	51
<b>8.12</b>	<b>Accessible surfaces.....</b>	<b>51</b>
8.12.1	Types .....	51
8.12.2	Requirements.....	52
8.12.3	Implementation.....	52
<b>8.13</b>	<b>Furnishings.....</b>	<b>52</b>
8.13.1	Types .....	52
8.13.2	Requirements.....	52
8.13.3	Implementation.....	53
<b>8.14</b>	<b>Solar panels.....</b>	<b>53</b>
<b>9</b>	<b>Requirements for the construction of vegetation areas.....</b>	<b>55</b>
<b>9.1</b>	<b>Functional layers.....</b>	<b>55</b>
<b>9.2</b>	<b>Construction methods, layer thicknesses .....</b>	<b>55</b>
9.2.1	Construction.....	55
9.2.2	Layer thicknesses .....	56
<b>9.3</b>	<b>Water Retention.....</b>	<b>57</b>
9.3.1	General .....	57
9.3.2	Maximum water capacity.....	58
9.3.3	Water permeability .....	58
9.3.4	Runoff coefficient/runoff reference value/coefficient of discharge .....	58
9.3.5	Additional retention performance.....	59
9.3.6	Annual runoff coefficient.....	60

<b>9.4</b>	<b>Water storage and additional irrigation .....</b>	<b>61</b>
9.4.1	Water storage.....	61
9.4.2	Additional irrigation.....	61
<b>9.5</b>	<b>Biodiversity of green roofs .....</b>	<b>62</b>
9.5.1	Materials/manufacture.....	62
9.5.2	Implementation.....	63
9.5.3	Maintenance .....	63
<b>10</b>	<b>Drainage Layer .....</b>	<b>64</b>
<b>10.1</b>	<b>Materials groups and types .....</b>	<b>64</b>
<b>10.2</b>	<b>Requirements .....</b>	<b>65</b>
10.2.1	Particle size distribution.....	65
10.2.2	Weatherability .....	66
10.2.3	Structure and layer stability .....	66
10.2.4	Compression behavior .....	66
10.2.5	Water permeability .....	66
10.2.6	Water storage capacity/maximum water capacity.....	67
10.2.7	pH values .....	67
10.2.8	Carbonate content.....	68
10.2.9	Salt content .....	68
<b>10.3</b>	<b>Manufacture.....</b>	<b>68</b>
<b>11</b>	<b>Filter Layer.....</b>	<b>69</b>
<b>11.1</b>	<b>Material groups and types .....</b>	<b>69</b>
<b>11.2</b>	<b>Requirements .....</b>	<b>69</b>
11.2.1	Area density .....	69
11.2.2	Mechanical stress resistance .....	69
11.2.3	Effectiveness of mechanical filtration/mesh width.....	70
11.2.4	Root penetrability .....	70
11.2.5	Weatherability .....	70
11.2.6	Resistance to microorganisms .....	70
11.2.7	Resistance to chemical influences.....	70
11.2.8	Coefficient of friction, elasticity and tensile strength,.....	70
<b>11.3</b>	<b>Manufacture.....</b>	<b>71</b>
<b>12</b>	<b>Vegetation Stratum .....</b>	<b>72</b>
<b>12.1</b>	<b>Material groups and types .....</b>	<b>72</b>
<b>12.2</b>	<b>Requirements .....</b>	<b>73</b>
12.2.1	Classification of the substrates for the greening types.....	74
12.2.2	Particle size distribution <sup>1)</sup> .....	75
12.2.3	Organic matter content.....	80
12.2.4	Weatherability .....	80

12.2.5	Structural and layer stability of soils and bulk materials .....	81
12.2.6	Compression behavior of substrate panels.....	81
12.2.7	Water permeability .....	81
12.2.8	Water storage ability/maximum water capacity.....	82
12.2.9	Air content.....	82
12.2.10	pH value.....	82
12.2.11	Salt content.....	83
12.2.12	Nutrient content.....	83
12.2.13	Adsorptive capacity .....	84
12.2.14	Content of viable seed regenerative plant parts.....	84
12.2.15	Foreign substances .....	84
<b>12.3</b>	<b>Manufacture .....</b>	<b>84</b>
<b>13</b>	<b>Requirements for Seeds, Plants and Vegetation .....</b>	<b>85</b>
<b>13.1</b>	<b>Breeding and trading groups.....</b>	<b>85</b>
<b>13.2</b>	<b>Requirements .....</b>	<b>85</b>
13.2.1	Seeds.....	85
13.2.2	Shoots.....	85
13.2.3	Perennials .....	86
13.2.4	Bulbs .....	86
13.2.5	Woody plants .....	86
13.2.6	Turf .....	87
13.2.7	Vegetation mats .....	87
<b>14</b>	<b>Planting and Seeding.....</b>	<b>88</b>
<b>14.1</b>	<b>Greening procedure.....</b>	<b>88</b>
<b>14.2</b>	<b>Implementation.....</b>	<b>89</b>
<b>14.3</b>	<b>Securing the stability of woody plants .....</b>	<b>89</b>
14.3.1	Requirements.....	89
14.3.2	Tension .....	89
14.3.3	Anchoring to support frames .....	90
<b>14.4</b>	<b>Erosion protection .....</b>	<b>90</b>
<b>14.5</b>	<b>Completion .....</b>	<b>90</b>
<b>14.6</b>	<b>Successful vegetative growth .....</b>	<b>91</b>

<b>15</b>	<b>Maintenance services for the development and maintenance of vegetation (development and maintenance care), maintenance .....</b>	<b>92</b>
<b>15.1</b>	<b>General .....</b>	<b>92</b>
<b>15.2</b>	<b>Intensive greening .....</b>	<b>92</b>
<b>15.3</b>	<b>Extensive greening .....</b>	<b>94</b>
<b>15.4</b>	<b>Maintenance .....</b>	<b>95</b>
<b>16</b>	<b>Acceptance, Claims for Defects .....</b>	<b>96</b>
<b>16.1</b>	<b>Acceptance .....</b>	<b>96</b>
<b>16.2</b>	<b>Claims for defects .....</b>	<b>96</b>
<b>17</b>	<b>Testing .....</b>	<b>97</b>
<b>17.1</b>	<b>Test and investigation reports.....</b>	<b>97</b>
<b>17.2</b>	<b>Structure of test and investigation reports .....</b>	<b>97</b>
	<b>Information Sources .....</b>	<b>111</b>
	<b>Appendix A: Informative orientation values for load assumptions and water storage ....</b>	<b>113</b>
	<b>Appendix B: Investigative methods for vegetation substrate and drainage bulk materials for green roofs.....</b>	<b>118</b>
	<b>Appendix C: Procedure for investigating the root penetration resistance of membranes and coatings for green roofs.....</b>	<b>133</b>

---

## Index of Figures and Tables

---

### Index of Figures

Figure 1:	Schematic representation of surface erosion, slipping and exceeding the angle of repose .....	46
Figure 2:	Surface formation of the substrate as a function of angle of repose, roof pitch and when installing shear ties .....	47
Figure 3:	Particle size distribution range for single-layer intensive substrates (except greening with turf) .....	76
Figure 4:	Particle size distribution range for multi-layer intensive substrates (except greening with turf) .....	77
Figure 5:	Particle size distribution range for single-layer turf substrates .....	78
Figure 6:	Particle size distribution range for multi-layer turf substrates .....	78
Figure 7:	Particle size distribution range for single-layer extensive substrates .....	79
Figure 8:	Particle size distribution range for multi-layer extensive substrates .....	80

### Index of Tables

Table 1:	Exemplary comparison of values of percent fall and degree pitch .....	29
Table 2:	Measures to prevent material displacement on flat and pitched roofs depending on the roof pitch .....	50
Table 3:	Thicknesses of different greening and vegetation types .....	57
Table 4:	Reference values for the percentage annual water retention and the annual runoff coefficient for green roofs depending on the structural thickness of bulk materials <sup>1)</sup> .....	60
Table 5:	Limiting the content of silts and clays ( $d \leq 0.063$ mm) for substrates of different planting types <sup>1)</sup> .....	75
Table 6:	Overview of particle size distribution ranges <sup>1)</sup> .....	75
Table 7:	Coordinates of the particle size distribution range for intensive substrates (except greening with turf) .....	76
Table 8:	Coordinates of the particle size distribution range for turf substrates .....	77
Table 9:	Coordinates of the particle size distribution range for extensive substrates .....	79
Table 10:	Organic matter content .....	80
Table 11:	Water permeability of vegetation substrates .....	81

Table 12: Conversion table for the water permeability of the vegetation stratum .....	82
Table 13: Water capacity of vegetation substrates .....	82
Table 14: Nutrient contents in vegetation substrates for intensive and extensive greening, investigation methods (determination according to VDLUFA) .....	83
Table 15: Proof of the properties of materials for drainage layers in the context of suitability and inspection testing .....	98
Table 16: Proof of the properties of vegetation substrates in the scope of suitability and Inspection testing .....	99
Table 17: Requirements for the vegetation engineering properties of bulk materials for drainage layers .....	100
Table 18: Requirements for vegetation engineering properties of vegetation substrates for multi-layer intensive greening (except turf greening) .....	101
Table 19: Requirements for vegetation engineering properties of vegetation substrates for multi-layer extensive greening .....	103
Table 20: Requirements for vegetation engineering properties of vegetation substrates for single-layer intensive and extensive greening (except turf greening) .....	105
Table 21: Requirements for the vegetation engineering properties of vegetation substrates for turf greening with multi-layered construction .....	107
Table 22: Requirements for the vegetation engineering properties of vegetation substrates for turf greening with single-layered construction <sup>6</sup> .....	109
Table 23: Load assumptions and water storage of bulk materials, mats and panels for drainage layers as well as for protective layers at maximum water capacity .....	113
Table 24: Load assumptions and water storage of vegetation strata at maximum .....	115
Table 25: Load assumptions and water storage of substrate panels, vegetation mats and water storage layers at maximum water capacity .....	116
Table 26: Last assumptions of the vegetation forms .....	117
Table 27: Overview of investigation methods for vegetation substrates and drainage-layer bulk materials for green roofs .....	120

---

## Preface

---

The FLL "Green Roof Guidelines – Guidelines for the Planning, Construction and Maintenance of Green Roofs" were developed from the "Principles for Green Roofing" published in 1982 and have been revised several times since 1990. They are recognized as a benchmark set of guidelines for green roofs in Germany. Abroad, the FLL Green Roof Guidelines are noted with great acceptance and serve as a basis for the development of national regulations in some neighboring countries.

The FLL has revised the 2008 edition in the Editorial Board (EB) Green Roofs, which was valid until now. One major change is the fundamental revision of the topic 'Securing against material displacement on flat and pitched roofs'. For the first time, the different forms of material displacement, such as surface erosion, slippage and exceeding the angle of repose are now considered separately. Corresponding safeguards against these three types of material displacement are described. In addition, topics have been supplemented that have been subject to technical developments and where new issues have arisen. Turf greening has been taken up as a vegetation with its own turf substrate requirement profiles. The issue of biodiversity of green roofs is another new topic being considered, since a better protection of the flora and fauna than providing habitats on roofs will hardly be possible to achieve in urban areas.

Finally, the information on the neighboring works of roof and building waterproofing has been adapted due to the extensive and fundamental changes to DIN 18195, DIN 18531, DIN 18532 and DIN 18533.

In the 'White Paper Urban Green' from the Federal Ministry for the Environment, Nature Conservation, Construction and reactor safety it says, "Greening buildings has an impact on the climate in cities. The environmental and urban climatic effects of greening roofs and facades are so far little known. Therefore, the federal government will analyze the effects of green facades and roofs in inner-city neighborhoods and will develop a guide for builders, owners and tenants on the possibilities of greening buildings".

The FLL Green Roof Guidelines are an important instrument in the structural implementation of these goals and other efforts to increase the proportion of green infrastructures in urban areas

We would sincerely like to thank the members of the Editorial Board (EB) and the Working Group (WG) "Dachbegrünungen", without whose great honorary commitment it would not have been possible to continue and develop standards for the greening of roofs.

Bonn, in July 2018



Prof. Dr. Ulrich Kias  
President of the FLL

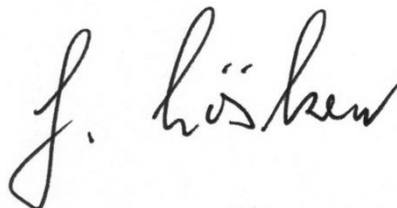

Prof. Gilbert Lösken  
Head of the EB and WG Green Roofs

---

# 1 Scope, Purpose

---

## 1.1 Scope

The "Guidelines for the Planning, Execution and Maintenance of Green Roofs – Green Roof Guidelines" apply to intensive greening, simple intensive greening and extensive greening on roofs and ceilings/decking e.g., roof terraces, hall roofs, underground garages and other building decking with generally up to 2 m overhang (section 9.2.2, table 3).

Should other requirements be placed on the planned construction or on the vegetation layer - also for partial areas, then it is necessary to examine whether deviations from the individual guidelines are necessary e.g., if

- when using thicker construction layers the principles of Landscaping according to DIN 18915 or the principles of Earthmoving according to ATV DIN 18300 need to be adhered to;
- in the case of turf sports fields or other load-bearing lawns, DIN 18035-4 should apply for the vegetation layer;
- in individual cases when planting trees in the vegetation layer, the FLL-„Empfehlungen für Baumpflanzungen – Teil 2: Standortvorbereitungen für Neupflanzungen“ [Recommendations for tree planting - Part 2: Site preparation for new plantings] should apply;
- other types of greening, forms of vegetation or uses are planned (e.g. planted water features, marsh planting, horticultural production areas, meadows, orchards, renewable raw materials etc.) and therefore the construction methods along with materials and structural elements need to be adjusted to meet the demands of the greening goals;
- in the case of retention roofs, water discharge is to be slowed in the greening structure or backed up and temporarily stored in an additional layer. The discharge is different from the usual drainage under defined conditions.

For traffic areas on buildings see FLL-„Empfehlungen zu Planung und Bau von Verkehrsflächen auf Bauwerken“.

## 1.2 Purpose

The greening of buildings is one of the possibilities for ecological, functional and design improvement of the living and working environment. This applies to intensive greening as well as simple intensive greening and extensive greening and includes construction methods as well as building materials and plant use.

The purpose of the guidelines is to present general principles and requirements for planning, execution and maintenance that conform to the current state of knowledge and reflect state-of-the-art technology. They relate to the object level with supplementary planning and construction fundamentals and focus on the building and vegetation engineering requirements. They are aimed at professionals of all participating disciplines and trades.

---

## 2 Normative References

---

The documents listed in this section contain stipulations that are necessary for the application of these guidelines.

In the case of dated references, the stated edition applies; for undated references, the current edition of said document applies.

### **LAWS, REGULATIONS OR SIMILAR**

- Düngegesetz (DüngG) [Fertilizing Act] from 9 January 2009, Federal Law Gazette (BGBl.) I p. 54, 136, last amended by Article 2 of the law of 31 July 2009 (BGBl. I p. 2539).
- Verordnung über das Inverkehrbringen von Düngemitteln, Bodenhilfsstoffen, Kultursubstraten und Pflanzenhilfsmitteln (Düngemittelverordnung – DüMV) [Ordinance on the Marketing of Fertilizers, Soil Additives, Cultivation Substrates and Plant Additives] of 16 December 2008 (BGBl. I p. 2524), last amended by Article 1 of the Ordinance of 14 December 2009 (BGBl. I p. 3905).

### **German Construction Contract Procedures – (VOB)**

#### **Part C: General Technical Specifications in Construction Contracts – (ATV)**

- DIN 18299 General rules applying to all types of construction work
- DIN 18300 Earthworks
- DIN 18320 Landscape works

#### DIN-Standards:

DIN 1986-30	Drainage systems on private ground - Part 30: Maintenance
DIN 1986-100	Drainage systems on private ground - Part 100: Specifications in relation to DIN EN 752 and DIN EN 12056
DIN 4045	Wastewater engineering - Vocabulary
DIN 4102-4	Fire behaviour of building materials and building components - Part 4: Synopsis and application of classified building materials, components and special components
DIN 4102-7	Fire behaviour of building materials and building components - Part 7: Roofing; definitions, requirements and testing
DIN 4426	Equipment for building maintenance - Safety requirements for workplaces and accesses - Design and construction
DIN 18035-4	Sports grounds - Part 4: Sports turf areas
DIN 18040-1	Construction of accessible buildings - Design principles - Part 1: Publicly accessible buildings
DIN 18040-2	Construction of accessible buildings - Design principles - Part 2: Dwellings
DIN 18040-3	Construction of accessible buildings - Design principles - Part 3: Public circulation areas and open spaces
DIN 18195	Waterproofing of buildings - Vocabulary

- DIN 18531-1 Waterproofing of roofs, balconies and walkways - Part 1: Non-utilized and utilized roofs - Requirements and principles for execution and design
- DIN 18531-2 Waterproofing of roofs, balconies and walkways - Part 2: Non-utilized and utilized roofs - Materials
- DIN 18531-3 Waterproofing of roofs, balconies and walkways - Part 3: Non-utilized and utilized roofs - Selection, execution and detailing
- DIN 18532-1 Waterproofing of concrete areas trafficable by vehicles - Part 1: Requirements and principles for design and execution
- DIN 18533-1 Waterproofing of elements in contact with soil - Part 1: Requirements and principles for design and execution
- DIN 18915 Vegetation technology in landscaping - Soil working
- DIN 18916 Vegetation technology in landscaping - Plants and plant care
- DIN 18917 Vegetation technology in landscaping - Turf and seeding
- DIN 18918 Vegetation technology in landscaping - Biological methods of site stabilization - Stabilization by seeding and planting, stabilization by means of living plant material, dead material and building elements, combined construction methods
- DIN 18919 Vegetation technology in landscaping - Care of vegetation during development and maintenance in green areas

DIN EN-Standards:

- DIN EN 1717 Protection against pollution of potable water installations and general requirements of devices to prevent pollution by backflow
- DIN EN 1990 Eurocode: Basis of structural design; German version EN 1990:2002 + A1:2005 + A1:2005/AC:2010
- DIN EN 1991-1-1 Eurocode 1: Actions on structures - Part 1-1: General actions - Densities, self-weight, imposed loads for buildings; German version EN 1991-1-1:2002 + AC:2009
- DIN EN 1991-1-2 Eurocode 1: Actions on structures - Part 1-2: General actions - Actions on structures exposed to fire; German version EN 1991-1-2:2002 + AC:2009
- DIN EN 1991-1-3 Eurocode 1: Actions on structures - Part 1-3: General actions - Snow loads; German version EN 1991-1-3:2003 + AC:2009
- DIN EN 1991-1-4 Eurocode 1: Actions on structures - Part 1-4: General actions - Wind actions; German version EN 1991-1-4:2005 + A1:2010 + AC:2010
- DIN EN 12056-3 Gravity drainage systems inside buildings - Part 3: Roof drainage, layout and calculation
- DIN EN 15026 Hygrothermal performance of building components and building elements - Assessment of moisture transfer by numerical simulation; German version EN 15026:2007

### DIN EN ISO-Standards:

DIN EN ISO 12958	Geotextiles and geotextile-related products - Determination of water flow capacity in their plane (ISO 12958:2010); German version EN ISO 12958:2010
DIN EN ISO 17892-4	Geotechnical investigation and testing - Laboratory testing of soil - Part 4: Determination of particle size distribution (ISO 17892-4:2016); German version EN ISO 17892-4:2016
DIN EN ISO 25619-2	Geosynthetics - Determination of compression behaviour - Part 2: Determination of short-term compression behaviour (ISO 25619-2:2015); German version EN ISO 25619-2:2015

### **REGULATORY WORKS, GUIDELINES, LEAFLETS**

#### **BUNDESFACHABTEILUNG BAUWERKSABDICHTUNG IM HAUPTVERBAND DER DEUTSCHEN BAUINDUSTRIE (HDB)**

- Technische Regeln für die Planung und Ausführung von Abdichtungen gegen von außen drückendes Wasser – BWA-Richtlinien für Bauwerksabdichtungen

#### **DEUTSCHE GESETZLICHE UNFALLVERSICHERUNG E.V. – DGUV**

- DGUV Vorschrift 38 mit BGV/GUV-V C22 DA
- DGUV Informationen 201-056

#### **DEUTSCHES INSTITUT FÜR GÜTESICHERUNG UND KENNZEICHNUNG E.V. RAL (GÜTEGEMEINSCHAFT SUBSTRATE FÜR PFLANZENBAU E.V.)**

- Güte- und Prüfbestimmungen Dachsubstrate, Gütesicherung RAL–GZ 253

#### **DEUTSCHER DACHGÄRTNER VERBAND E.V. DDV**

- DDV-Leitfaden Sicherer Gewerkeübergang

#### **FACHVEREINIGUNG BAUWERKSBEGRÜNUNG E.V. – FBB**

- Wurzelfeste Bahnen und Beschichtungen, Prüfungen nach dem FLL-Verfahren
- Pflanzenarten mit starkem Rhizom-Wachstum, wie Bambus und Schilf

#### **FORSCHUNGSGESELLSCHAFT FÜR STRAßEN- UND VERKEHRSWESEN FGSV**

- M Geok E – Merkblatt über die Anwendung von Geokunststoffen im Erdbau des Straßenbaues

#### **FORSCHUNGSGESELLSCHAFT LANDSCHAFTSENTWICKLUNG LANDSCHAFTSBAU E.V. – FLL**

- Bewässerungsrichtlinien – Richtlinien für die Planung, Installation und Instandhaltung von Bewässerungsanlagen in Vegetationsflächen
- Bewertung von Dachbegrünungen; Empfehlungen zur Bewertung in der Bauleitplanung, bei der Baugenehmigung und bei der Bauabnahme
- Empfehlungen für Baumpflanzungen
  - Teil 1: Planung, Pflanzarbeiten, Pflege
  - Teil 2: Standortvorbereitungen für Neupflanzungen; Pflanzgruben und Wurzelraumerweiterung Bauweisen und Substrate
- Empfehlungen für Begrünungen mit gebietseigenem Saatgut
- Empfehlungen zu Planung und Bau von Verkehrsflächen auf Bauwerken
- Empfehlungen zur Versickerung und Wasserrückhaltung
- Gütebestimmungen für Baumschulpflanzen
- Gütebestimmungen für Stauden
- Hinweise zur Pflege und Wartung von begrüntem Dächern
- Leitfaden „Gebäude, Begrünung, Energie – Potenziale und Wechselwirkungen (Forschungsbericht, 2014)

- Regel-Saatgut-Mischungen Rasen – RSM
- TL Fertigrasen – Technische Lieferbedingungen für Rasensoden aus Anzuchtbeständen

**HAUPTVERBAND DER GEWERBLICHEN BERUFGENOSSENSCHAFTEN – HVBG**

- Unfallverhütungsvorschriften Bauarbeiten BG-Vorschriften C 22 VBG 37
- Durchführungsanweisungen Bauarbeiten BGW C 22 DA

**SOZIALVERSICHERUNG FÜR LANDWIRTSCHAFT, FORSTEN UND GARTENBAU – SVLFG**

- Unfallverhütungsvorschrift Gartenbau, Obstbau und Parkanlagen, VSG 4.2

**ZENTRALVERBAND DES DEUTSCHEN DACHDECKERHANDWERKS – FACHVERBAND DACH-, WAND- UND ABDICHTUNGSTECHNIK E.V. UND HAUPTVERBAND DER DEUTSCHEN BAUINDUSTRIE E.V. BUNDESFACHABTEILUNG BAUWERKSABDICHTUNG**

- Fachregel für Abdichtungen – Flachdachrichtlinie

---

## 3 Definitions

---

### **Bulk shift when creating the angle of repose**

Occurs in artificially tipped or installed materials e.g., green roof substrates. In the long term, the natural angle of repose of the material sets in. It can come to a mass movement, in which the shear gap passes through the bulk material. In this case, the shear force in the bulk material exceeds the internal friction angle of the material.

### **Completion care**

⇒ Maintenance phase

### **Development care**

⇒ Maintenance phase

### **Drainage layer**

The drainage layer (see section 10) absorbs excess water due to its hollow structure and feeds it to the roof drains. With appropriate construction materials, it also serves as water storage, increases the rootable space and takes over a protective function for the underlying structure.

### **Filter layer**

The filter layer (see section 11) prevents finer soil and substrate parts slipping from the vegetation into the drainage layer thereby impairing the water permeability of this layer.

### **Maintenance Care**

⇒ Maintenance phase

### **Maximum water capacity**

This describes the amount of water held by a water-saturated substance after dripping for two hours.

### **Maintenance phases**

DIN 18916, DIN 18917 and DIN 18919 distinguish the following maintenance phases:

Services for completion (Completion care)	Achieving successful growth requires completion services (completion care) after planting. These have the goal of achieving a condition, which with subsequent maintenance services in accordance with DIN 18919, enables secure further development. (According to DIN 18916 Vegetation technology in landscaping - Plants and plant care).
Maintenance services for development (Development care)	Services to achieve a functional condition. They follow the services for completion (completion care) according to DIN 18916, DIN 18917. The duration until the functional condition is reached depends on the type of vegetation and the location conditions. E.g. for a lawn a few weeks and for trees lasting up to 15 years. (According to DIN 18919 Vegetation technology in landscaping - Care of vegetation during development and maintenance in green areas (development and maintenance care).
General maintenance services (maintenance care)	Services for the maintenance of the functional condition. These services are linked to the maintenance services for development. (According to DIN 18919 Vegetation technology in landscaping - Care of vegetation during development and maintenance in green areas (development and maintenance care).

### **Protective layer**

Protective layer and protective measures serve to protect the roof waterproofing and/or the root penetration barrier.

#### **Protective ply/protective layer**

Permanent protection of a waterproofing layer using membrane substances against mechanical and/or thermal and/or chemical action.

#### **Protective ply**

Temporary protection of a waterproofing layer during the construction phase

#### **Protective layer**

Permanent, possibly also load-distributing protection of a waterproofing layer against mechanical and/or thermal and/or chemical action (see section 8.3).

### **Root area / rootable area**

Area of green roofs that can maintain roots. It includes both the vegetation-bearing layer and the area of the drainage layer.

### **Root penetration barrier**

The root penetration barrier must permanently prevent damage to the waterproofing caused by penetrating plant roots and possibly rhizomes (see section 8.2 and appendix C).

### **Runoff coefficient**

Runoff coefficient is used in calculations of precipitation runoffs taking into account different runoff behaviors depending on the roof conditions. The runoff coefficient is used to determine the percentage of rainfall that reaches the drain in a specific period of time.

#### **Peak runoff coefficient**

Peak runoff coefficient  $C_s$  according to DIN 1986-100 for the calculation of the effective runoff area for the design of roof drains and pipe cross-sections and flood prevention. It reflects the ratio of rainfall intensity to rainwater runoff within the period of the rainfall.

#### **Annual runoff coefficient**

Annual runoff coefficient  $\Psi_a$  is a characteristic value for assessing the actual water retention by green roofs in the seasonal sequence with free weathering, as a measure of the annual retention capacity.

#### **Mean discharge coefficient**

Mean discharge coefficient  $C_m$  according to DIN 1986-100 for the calculation of the volume of rainwater retention space.

### **Separating ply**

A separating layer causes the separation of substances that are chemically incompatible with each other.

### **Sliding ply**

A sliding layer prevents the unwanted transmission of forces to adjacent substances under one another and reduces the frictional forces between two layers.

### **Slippage**

Also sliding, describes a mass movement (layers of the green structure) along a layer boundary. It starts when the downward forces on one level exceed the friction at the layer boundary. As the slope of a surface increases, the downward forces increase and thus the risk of slippage increases.

### **Surface erosion**

Is a particle transport along a substrate or soil surface due to the action of e.g., wind, water or ice.

### **Substrate**

A soil replacement made from materials mixed together or from prepared soils according to defined requirements for the vegetation.

### **Types of green roof**

To differentiate between different green roofs, three types of greening with different uses and different levels of effort in production and care are distinguished:

#### **Intensive green roofs**

As a rule, used and higher quality garden areas on the roof with high expenditure for installation and care.

#### **Simple intensive green roofs**

Used or unused, mostly simply designed green areas on the roof with less expenditure for installation and care.

#### **Extensive green roofs**

Usually unused natural green areas on the roof with low cost installation and care.

### **Vegetation layer**

The vegetation-bearing layer (see section 12) forms the basis for plant growth and must be intensely rootable.

---

## 4 Legal Framework Conditions

---

Green roofs generally do not require separate planning permission. Legal requirements arising from the respective national, state or bylaws must be examined.

### 4.1 Construction planning law

In the development plan applicable to the property, concrete arrangements regarding the design and execution of roof areas may be included for reasons of urban planning, climatic conditions, nature conservation or water management. These can be minimum standards for green roofs e.g., with regard to substrate application, vegetation type, use of open space or rainwater storage. When designating green roofs and renewable energy exploitation, if necessary, priority must be given or compatibility demanded.

### 4.2 Building regulations

The applicable state building regulations specify whether planning permission is required for the construction of a green roof.

- In the case of subsequent green roofs (without independent use), it can generally be assumed that a green roof - as part of the roofing - does not require planning permission. However, if an exemption or exception from the development plan is required, separate permission would have to be requested from the responsible building supervisory authority. Incidentally, even in the case of green roofs where permission is not required, the building owner must observe the public-law regulations for the construction and maintenance.
- If a purposeful use of a green roof is likely, e.g. as living quarters or energy production facilities, planning permission may be required. State, municipal or neighborhood law regulations must be taken into account. The building plans (floor plan, building description, etc.) to be submitted is determined by the building regulations issued by the planning authority. If necessary, evidence of viability, traffic safety and fire safety must be provided to ensure safe use.
- Some cities and local authorities have issued statutes or regulations that regulate the greening of buildings for architectural or ecological reasons.

### 4.3 Preservation

In the case of structures registered as listed buildings, special permission is required in individual cases.

### 4.4 Conservation

Green roofs, which according to §15 of the Federal Nature Conservation Act (BNatSchG) are determined as compensating or minimizing interventions in nature and landscape, are subject to special protection status. Structural and maintenance-related changes require nature conservation approval here.

### 4.5 Wastewater law

Construction law quality standards as well as country-specific wastewater law requirements apply to the materials used, with regard to the direct and indirect discharge of roof and drainage water.

---

## **5 Types of Green Roof and Forms of Vegetation**

---

### **5.1 Types of green roof**

#### **5.1.1 General information**

Green Roofs are divided into three different types, depending on use, construction factors and the method used to carry out the work. These play a critical part in determining both the plant types which are selected and how the vegetation will look:

- intensive green roofs;
- simple intensive green roofs;
- extensive green roofs.

Each type of green roof includes a variety of vegetation forms with flowing transitions and location-dependent differentiations subject to dynamic changes. Taking into account experiences with the use of plants and findings from vegetation science, the three types of green roofs can be differentiated from each other by the following distinguishing criteria.

#### **5.1.2 Intensive green roofs**

Intensive greening may consist of perennials, grasses, flower bulbs, summer flowers and shrubs, in some cases trees, as well as lawns. They can be flat, height-differentiated or punctually constructed. They are comparable with ground-based open spaces in the possibilities of use and design diversity with appropriate equipment.

The plants used place high demands on the layer structure.

This type of green roof can only be sustained through intensive care, especially regular water and nutrient supply.

#### **5.1.3 Simple intensive green roofs**

Simple intensive greening is usually designed with ground cover plants, grasses, perennials and shrubs. The variety of uses and design is limited in comparison to an intensive green roof.

The plants used make lower demands on the layer structure as well as on the supply of water and nutrients.

The production cost is lower than for intensive green roofs. Maintenance measures are required to a reduced extent. Depending on the greening aims, some invasive vegetation, e.g. ground cover plants, herbaceous plants and moss can be tolerated.

#### **5.1.4 Extensive green roofs**

Extensive greening represents natural forms of vegetation that are largely self-sustaining and evolving.

Plants with special adaptation to extreme site conditions and high regeneration capacity are used. The plants should originate from the Central European floras or be naturalized.

The aim of extensive greening can be to initiate vegetation development in a shorter time than spontaneous self-vegetation and to establish permanent populations with the help of natural vegetation dynamics.

The mostly unbroken areas of vegetation are formed from mosses, succulents, herbs and grasses and can be supplemented by bulbous and tuberous plants. The vegetation is subject to the natural reshuffle, whereby other plant species can settle. If a certain vegetation is to be retained e.g., a given vegetation pattern with regular full-scale flowering of herbs and succulents, or the target vegetation is recognized and maintained as a compensatory measure, a small but targeted, regular supply of nutrients and appropriate care may be required.

In particular, if the vegetation on sloping roofs is to ensure erosion protection, a weather-dependent water supply may be required.

The effort involved in the production and maintenance of extensive greening is usually lower than for the forms of intensive greening. The necessary maintenance measures depend, among other things, on the greening goal, the regional climatic conditions and the construction method.

### **5.2 Forms of vegetation**

#### **5.2.1 General**

When using plants, the variety of design, ecological and functional aspects ranges from the use of horticultural cultivars for intensive planting to the settlement of wild plants in extensive green areas that display biotope characteristics and are similar to natural plant communities.

The following differentiation of the vegetation forms can only be exemplary given the multitude of possibilities and is based on the population-forming plant groups. Depending on the object, different vegetation aspects may develop on sub-areas due to deviating site conditions.

The desired target vegetation must be clearly described and specified in the bill of quantities. This also applies to maintenance measures and possible changes in terms of site conditions. Site-appropriate, invasive vegetation of herbs and mosses is tolerable, provided that they do not have a repressive effect and are not contrary to design or use intentions.

#### **5.2.2 Vegetation forms of intensive green roofs**

Intensive greening includes the almost unlimited plant and design variety available in open space planning, which allows any form of vegetation.

Restrictions in the use of trees and large shrubs can exist depending on the object. They can also extend to species of other vegetation groups based on the special site conditions.

### **5.2.2.1 Kitchen gardens**

A special form of intensive green roofs are kitchen gardens. The main difference to a typical intensive green roof is the possibility of a regular recultivation by nonprofessionals. Structurally, the rooftop kitchen gardens are to be laid out in such a way that the gardeners cannot cause any damage to the elements of the roof construction, such as the underlying roof skin. The plantable areas must be laid out in such a way that the safety of the garden users during gardening is guaranteed (e.g. fall protection).

### **5.2.2.2 Greening with turfs**

Grass areas for games, sports and representation purposes are a special form of intensive greening. A prerequisite for a functioning system is a clarification of the location conditions such as light (reflection of glass facades, shadows), wind (erosion, dehydration) and precipitation conditions (extraneous water, rain shadow) and their involvement in the planning.

Due to the high water requirement and the comparatively low root depth, a permanently installed irrigation system is recommended for turfed areas.

Turfs are intensively cultivated. Above all, mowing and the supply of water and nutrients must be carried out regularly in order to maintain the greening long-term. Too little care can lead to a lack of growth or a stock conversion.

### **5.2.3 Vegetation forms of simple intensive greening**

In simple intensive greening, which also form the transition from intensive to extensive green areas, the following main vegetation forms can be distinguished for characterization:

- grass-herbaceous planting;
- wild perennials-shrub planting;
- woody shrubs-perennial planting;
- woody plants.

### **5.2.4 Vegetation forms of extensive greening**

In extensive greening, the following main vegetation forms can be distinguished for characterization:

- moss and sedum planting;
- sedum-moss-herbaceous planting;
- sedum-grasses-herbaceous planting;
- grasses-herbaceous plants.

In the assessment and classification of the vegetation forms, the vegetation aspects in the general dormancy must be considered. Individual plant groups, in particular mosses, can be temporary and partially population forming.

## **5.3 Determination of site conditions for vegetation**

### **5.3.1 General**

Determining the site conditions for vegetation is an essential prerequisite for ensuring the lasting success of green roofs.

Factors determining the conditions are:

- climate and weather-dependent factors;
- structure-specific factors;
- plant-specific factors.

### **5.3.2 Climate and weather-dependent factors**

The following factors are to be considered:

- the regional climate conditions;
- the local microclimate;
- the amount and spread of annual precipitation;
- average hours of insolation;
- any periods of drought;
- any periods of frost, with or without snow cover;
- the prevailing wind direction.

### **5.3.3 Structure-dependent factors**

The following factors are to be considered:

- sunny, shaded and dappled shade areas;
- deflection of precipitation by the building;
- the effect of flue gas emissions;
- wind flow conditions;
- exposure of the roof surfaces;
- stress due to reflecting façades;
- additional water load from adjoining structural elements;
- the gradient or pitch of the roof surfaces and the length;
- design loads and the resulting depth of the structured layers;
- additional technical installations, e.g. air-conditioning units, antenna, solar panels;
- puddle forming on the roof.

#### 5.3.4 Plant specific factors

The following factors are to be considered:

- certain individual species are not fully hardy, particularly evergreens in a limited substrate thickness;
- the wind stability of shrubs and perennials in exposed positions;
- the sensitivity of some species to reflected light and thermal build-up;
- the sensitivity of all plant species to airborne chemical emissions, also to warm and cold air emissions;
- the runners of various species und cultivar;
- grasses with aggressive rhizome growth, e.g. bamboo species, may need extra protective-membranes to protect structural elements from penetration;
- the growth pressure of subterranean plant parts (roots and rhizomes) on building elements;
- the appearance of host growth on grafted stock;
- the competitive weakness of different species and cultivar in thinner substrate layers.

For extensive greening, he following factors are to be considered:

- the effect of the wind and the intensity of insolation on water storage;
- the demands on aeration of the substrate made by plants in dry locations;
- the sensitivity also of these types of plant to airborne chemical emissions, also to warm and cold air emissions;
- the transformation towards forms of vegetation for damp or permanently damp locations in shady conditions or in wet areas, e.g. at < 2 % fall;
- the weaker competitive species and cultivar in comparison to migratory flora from the vicinity
- the temporary or permanent reshuffling of moss species for seasonal reasons or the lack of competition of settled herbs, grasses or succulents;
- the possibility of increased non-native vegetation by immigrant species from the surrounding flora. This refers to woody plants, e.g. poplars, willows, birches, as well as herbs and grasses. This must be taken into account for care and maintenance during the planning phase;
- for more steeply inclined roofs, the different vegetation formations on sun-exposed and shady surface areas as well as in the ridge area and at the eaves.

---

## **6 Function and effects**

---

### **6.1 General**

Green roofs fulfil a number of interconnecting functions and effects. They fall under three main headings:

- Urban and open space planning;
- Ecological;
- Protective and economic.

They can occur in different ways and to different extents depending on the situation. A breakdown according to the essential aspects is therefore not free of overlaps and can only be an example, whereby the sequence does not include a rating.

The functions and effects are used in the context of environmental impact assessments and intervention regulations for the assessment of construction measures, whereby a different approach and weighting is applied in individual municipalities and federal states. In order to guarantee the desired functions and effects for appropriate requirements, it is recommended to set minimum standards with regard to the structure and thickness of the layers as well as the vegetation form (see also FLL "Bewertung von Dachbegrünungen").

### **6.2 Urban and open space planning functions and effects**

- Creation of additional green space and open space on the same plot of land without additional land acquisition costs;
- Conservation and reclamation of green spaces and open spaces as compensation measures at sites subject to development or sealing;
- Improvement of the cityscape and landscape through increased introduction of plants, green elements and green areas as accentuating, articulating and space-forming design elements;
- improvement of the living and working environment by assigning perceptible and usable private and public open spaces to the immediate living and working area of the people;
- Improvement of the natural experience of visible roof areas in the vicinity through plantings, green elements and green areas compared to freely weathered or graveled roof areas.

### **6.3 Ecological functions and effects**

- Taking into account the issues of landscape planning, landscape management and nature conservation in residential areas and in the open countryside;
- Creation of reference areas and species-rich habitats for the displaced flora and fauna in residential areas;
- Delayed runoff and retention of rainwater and reintroduction into the natural cycle through evaporation and transpiration;
- Microclimate improvement by compensating for temperature extremes, reducing the intensity of reflected radiation to adjacent areas, increasing humidity and improving dust retention compared to freely weathered or graveled roof areas.

### **6.4 Protective and economic functions and effects**

- Reduction of physical, chemical and biological stress on the roof structure, and in particular the roof waterproofing, by compensating for temperature extremes, preventing UV rays and emissions as well as preventing the formation of bubbles and encrustations;
- Limiting the risk of external mechanical damage to the roof waterproofing and reduction of wind suction influence;
- Protection against flying sparks and radiant heat;
- Improvement of footfall and airborne sound insulation;
- Improvement of winter and especially summer heat insulation;
- Reduction of the runoff coefficient for on-site drainage;
- Retention of rainwater;
- Easing pressure on city wastewater;
- Retention area for urban water management;
- Increase in property value through a representative green building;
- Image gain for the owner and user of the building through visibly sustainable and responsible action.

---

## 7 Requirements for construction and building materials

---

### 7.1 Planning Requirements

The characteristics of the building and the roof surfaces are to be determined and evaluated in terms of construction and vegetation engineering during planning. This may result in further special requirements for the construction of the building and the green roof as well as the unsuitability of certain types of greening or vegetation.

When planning the green roof construction, building requirements specified by the building engineers must be taken into account. This applies in particular to the load-bearing roof/deck construction and the insulation and waterproofing layer structures, including any necessary protection.

The transition point from the structural engineering planning to the greening planning must be determined at an early stage. This is usually at the top of the protective ply.

The contractual performance limit of implementation between waterproofing and the green roof must be determined during the planning phase and clearly defined in the bill of quantities. The service transfer lies e.g., above the waterproofing or above the protective ply.

The suitability of the sealed roof surface for the planned roof greening and use (statics, compressive strength, building physics, waterproofness, root/rhizome resistance) is to be confirmed to the client by the contracting party through attestation at acceptance.

The installer of the green roof installation must inspect the waterproofing, including the correct connection heights, by visual inspection before the start of implementation. In the case of obvious defects or critical areas, the client must be informed and the further procedure agreed.

### 7.2 Type of use/usability

When using, a distinction must be made between technical aspects relating to the roof construction and usability by humans. Structural aspects for use are specified in DIN EN 1991-1-1, DIN 18195, DIN 18531, DIN 18532, DIN 18533 and in the ZVDH/HDB "Fachregel für Abdichtungen – Flachdachrichtlinie".

The usability of green roofs by people is essentially limited to the provided and appropriately fortified footpaths and paved areas. The large-scale use of green roofs is only possible with appropriately resilient turf. Attention is drawn to the regulations for barrier-free building, DIN 18040-1, DIN 18040-2 and DIN 18040-3.

The intended use is to be communicated to the structural engineer for the structural calculation, in order to enable the determination of the live loads based on the use categories according to DIN EN 1991-1-1. When changing the use of green roofs, the changing live load in particular is to be considered. This change may, for example, be greater on paved areas used exclusively by people than in areas with vehicle traffic.

When used for recreational purposes, balustrades are required to protect against falling off.

### 7.3 Roof pitch/fall

With regard to the technical building and vegetation requirements of the green roof types, the roof pitches (degrees) or the roof falls (percent) must be observed.

For extensive green roofs and simple intensive green roofs, a fall of at least 2% should be planned. A controlled drainage meets the basic needs of extensive green vegetation.

Flat roofs and sub-areas such as eaves and valleys without, or with too little fall formation (<2%), may have an unintended water accumulation over entire or partial areas, which can be problematic for extensive greening. In this situation, plant failures and vegetation reshuffling as well as increased settlement of non-native vegetation (e.g., woody seedlings) can be expected.

The effectiveness of thicker layers or additional drainage layers in standing water is limited. As a result, the effects of waterlogging and increased water supply on vegetation development cannot be influenced as much as they could be with sufficient roof slope.

Limited remedies can be affected by making stagnant water largely inaccessible to plants. This can be achieved through the installation of e.g. a water-displacing or spacer layer (e.g., insulation elements possibly in combination with drainage panels). The areas with stagnant water and the expected water level are to be determined before the construction of the green roofs on roofs with insufficient gradient in order to be able to determine the appropriate measures. If these measures are unsuccessful in individual cases, it must be determined whether vegetation reshaping should be tolerated or whether from the outset another vegetation settlement adapted to the expected site conditions with increased water supply should be provided.

In the case of intensive green roofs with ponding irrigation, the roofs must be designed without gradient or with ridge ponding elements

**Table 1: Exemplary comparison of values of percent fall and degree pitch**

No.	1		2	
1	Fall in percent corresponds to inclination in degrees		Gradient in degrees corresponds to fall in percent	
2	1%	≅ 0.6°	1°	≅ 1.7%
3	2%	≅ 1.1°	2°	≅ 3.5%
4	3%	≅ 1.7°	3°	≅ 5.2%
4	5%	≅ 2.9°	5°	≅ 8.8%
4	7%	≅ 4.0°	7°	≅ 12.3%
5	9%	≅ 5.1°	9°	≅ 15.8%
6	10%	≅ 5.7°	10°	≅ 17.6%
7	15%	≅ 8.5°	15°	≅ 26.8%
8	20%	≅ 11.3°	20°	≅ 36.4%
9	30%	≅ 16.7°	25°	≅ 46.6%
10	40%	≅ 21.8°	30°	≅ 57.7%
11	60%	≅ 31.0°	35°	≅ 70.0%
12	80%	≅ 38.7°	40°	≅ 83.9%
13	100%	≅ 45.0°	45°	≅ 100.0%

With increasing gradient, the water runs off more rapidly. Above a roof pitch of 5° (about 8.8% fall) this should be compensated for by a layer structure with higher water storage capacity and lower drainage capacity or by a vegetation form with a lower water requirement.

With increasing roof slope, special measures against material displacement must be observed (see also section 8.10). Roofs with a pitch of more than 45° should not be greened because of the associated technical, structural and vegetation problems.

## **7.4 Roof construction and effective greening**

Depending on the roof construction, different structural and constructional requirements for greening, which refer to the suitability and effectiveness of all layers and materials in the roof construction, must be observed. In particular, we refer to the ZVDH/HDB "Fachregel für Abdichtungen – Flachdachrichtlinie" as well as to the "BWA-Richtlinien für Bauwerksabdichtungen; Technische Regeln für die Planung und Ausführung von Abdichtungen gegen von außen drückendes Wasser".

### **7.4.1 Roofs with waterproofing**

#### **Non-ventilated roof without thermal insulation**

All greening types and vegetation are possible, especially those with higher load assumptions. Frost damage to the vegetation cannot be ruled out for structures with roofs that can be exposed to negative temperatures on the underside.

#### **Non-ventilated roof with thermal insulation**

All greening types and vegetation are possible, especially those with higher load assumptions. The compressive strength of the thermal insulation material is to be adjusted to the loads of the vegetation structure including the load of the vegetation.

#### **Non-ventilated roof with thermal insulation on lightweight structures**

Generally, only greening with low load assumptions. Under certain circumstances, existing roofs may not be planted because of the low load reserve.

#### **Non-ventilated wooden roof with full rafter insulation**

According to the flat roof guidelines, wooden roofs with full rafter insulation without back ventilation of the waterproofing layer are considered harmful. Such flat roofs should not be planted for constructional reasons.

#### **Ventilated roof with thermal insulation**

Generally, the low load-bearing capacity of the upper shell is to be considered. The constructional processes can be influenced by the cooling effect of greening. The effects are to be checked in individual cases.

#### **Inverted roof**

When greening inverted roofs and corresponding special forms with thermal insulation above the roof waterproofing, the vapor diffusion processes must be considered. The extent to which compensating and diffusion-open intermediate layers are required, must be determined case by case. Additional measures may be required in particular during roof renovations.

#### **7.4.2 Roofs made from waterproof concrete (“WP-Concrete”)**

##### **Roofs made from waterproof concrete with or without a thermal insulation underlay**

Any type of greening and any form of vegetation may be used. Generally speaking, additional surface treatment for the concrete is not needed in order to prevent root penetration (see section 8.2.1).

##### **Roofs made from waterproof concrete with thermal insulation overlay**

Greening is possible as for inverted roofs.

#### **7.4.3 Roofs with decking**

The building methods and materials currently used for roofs with decking are not, generally speaking, intended for greening. Where structural conditions permit, it can also be possible to green these roofs. In some cases, special measures such as a waterproof underlay may be required.

### **7.5 Vapor diffusion**

The constructional characteristics of roof structures for green roofs must be checked during the planning stage. This applies to both new and, in particular, existing roofs. Here, attention needs to be paid to vapor diffusion depending on the room use.

Hygrothermal calculations, e.g. according to DIN EN 15026 (dynamic calculation method) are required for proof of moisture transfer functionality.

### **7.6 Load assumptions**

The static conditions, i.e. the load assumptions, are a limiting selection criterion for determining the type and construction of a green roof.

The structure with all its layers at maximum water capacity, including the areal load of the vegetation, is to be classified as part of the permanent effect. The load from the water stored during the ponding process is also to be considered. The point loads of large shrubs, trees and structural elements, e.g. pergolas, water basins, edging elements, are to be determined separately and taken into account accordingly (see also appendix A).

The sufficient compressive strength of the thermal insulation in connection with the roof waterproofing must be taken into account, in particular in the production of the green roof and the arrangement of point loads.

If the layers of the green roof structure are to serve as a load for the wind suction protection of the underlying roof structure, see section 8.8.

## 7.7 Protection against falling

Health and Safety accident prevention measures are to be taken into account during the planning and tendering stages for the building. This applies especially to fall prevention during execution, maintenance and servicing of buildings and the fall-through prevention for building elements (Skylights). Corresponding requirements include the construction site ordinance (BaustellV), the DIN 4426, the DGUV regulation 38 with BGV/GUV-V C22 DA, the DGUV information 201-056, as well as the accident prevention regulation of the "Unfallverhütungsvorschrift der Sozialversicherung für Landwirtschaft, Forsten und Gartenbau (Gartenbau-Berufsgenossenschaft) VSG 4.2".

Suitable safety measures can be e.g., barriers, anchorage for rope safety systems, permanent lifts with fall protection and entry options. Only tested products or systems are to be used. The responsibility for the safety measures lies with the client and his assigned planner or safety coordinator and safety officer.

During implementation work, fall protection in the form of balustrades on the roof or a façade scaffold is usually necessary. Particular attention should be paid to the coordination of the various trades, so that, for example, temporary safety scaffoldings are dismantled only after completion of the green roof.

For care and maintenance work, personal safety equipment against falling (PSAgA) is usually sufficient and appropriate anchor devices have to be provided by the client. For installation on roof waterproofing that has already been completed, it is advisable to attach the anchorage points without penetrating the roof skin, e.g. by attachment to rising structural elements or safety systems held by ballast.

## 7.8 Drainage

The planning of the drainage is to be carried out according to DIN EN 12056-3 and DIN 1986-100. In the case of green roofs, the planning must ensure that vegetated and non-vegetated areas can be properly dewatered. Extraneous water such as façade water or water from other roof areas must be considered separately.

The drainage must be ensured both in the layer structure and on the surface. In order to manage the surplus water of the entire roof area safely and in a controlled manner, when planning the drainage, the position of the drainage points is to be determined depending on the different surface formations. The following situations can be distinguished:

### 1. Drainage points within the vegetation area

Where boundary edging is planned, it must be ensured that the outlying areas are safely dewatered through or under the boundary edging;

### 2. Drainage points outside the vegetation area

In the case of boundary edging, it must be ensured that the vegetation area is safely dewatered through or under the boundary edging;

### 3. Separate drainage of vegetation and vegetation-free areas

All areas separated from each other from a drainage point of view, must be dewatered via their own drainage points and emergency overflows;

### 4. Drainage in roof valleys

If two roofs, sloping towards each other, are drained via one drainage channel or drain, the dimensioning must take into account the total drainage area of both surface areas;

## 5. Drainage via the roof eaves

If (sloping) roofs are drained over the eaves, care must be taken to adequately dimension the suspended gutters in order to prevent them from overflowing. The emergency drainage is done by overflowing the gutter. If the drainage at the edge of the roof is done internally via gutter and drain, the upstand at the edge of the roof must be high enough to prevent overflow during the design rain. Emergency drainage takes place by overflowing the edge of the roof if it can be determined that this will not cause damage, otherwise an emergency overflow (e.g. spout) is to be provided.

Roofs that dewater through systems running internally must have at least one drain and at least one emergency overflow regardless of the size of the roof surface. Drains and emergency overflows must be dimensioned according to DIN EN 12056-3 and DIN 1986-100.

For the design of drainage facilities in accordance with DIN EN 12056-3 and DIN 1986-100, the runoff coefficients listed in section 9.3.4 can be applied.

In the case of roof drainage with pressure flow, the following aspects are of particular importance in connection with green roofs:

- in the case of small green roof areas, check whether the rainwater runoff is sufficient to ensure the self-cleaning power of the pressure drainage system;
- In a pressure drainage system, the outflow at all drains should be approximately the same and therefore the connection of roof areas with different discharge delays should be avoided. Therefore, roofs with e.g., intensive greening, extensive greening, graveled roofs and un-graveled roofs should not be connected to one drainage line. This does not apply to the combination of different surface formations within a drainage field (e.g. intensive greening and extensive greening or greening and gravel areas) if at all drainage points of a drainage line the allocated percentage area is approximately the same and this results in a comparable runoff;
- Green roofs with water accumulation areas in the drainage layer should be dewatered with a separate free-flow system because the drainage behavior is difficult to assess and it is currently not possible to make precise statements about the effects on the pressure-flow roof drainage system;
- Regular maintenance of the dewatering system according to DIN 1986-30 is to be ensured.

In individual cases, it must be checked whether surplus water should be seeped or fed to a water retention system. See FLL-“Empfehlungen für Versickerung und Wasserrückhaltung“ [Seepage and Water Retention Recommendations] for details.

## 7.9 Irrigation

Irrigation shall be provided by at least one water connection on the roof, which is protected against frost by technical installation or maintenance.

The dimensioning and number of supply lines and connections as well as the required water pressure for irrigation are dependent on the local situation, the structural conditions, size and layout of the object as well as the intended vegetation form and are to be considered in the planning. The specifications according to DIN EN 1717 are to be observed. See also FLL-Bewässerungsrichtlinien – Richtlinien für die Planung, Installation und Instandhaltung von Bewässerungsanlagen in Vegetationsflächen.

## **7.10 Materials**

According to ATV DIN 18299, substances and components must be suitable and coordinated with each other for the respective purpose.

In the case of material for the roof and greening construction, this applies in particular to their mutual chemical compatibility. The material manufacturers generally make corresponding use restrictions known.

In the case of incompatibility, the choice of materials is to be checked or a separating ply installed.

## **7.11 Environmental compatibility**

The substances used may not trigger, e.g. either by leaching or by the escape of gaseous substances, polluting effects. The Federal and State laws and regulations as well as local regulations concerning pollution and environmental compatibility must be observed. When selecting materials, recycling or disposal should be taken into account.

According to the Düngegesetz (DüngG) und Düngemittelverordnung (DüMV - Verordnung über das Inverkehrbringen von Düngemitteln, Bodenhilfsstoffen, Kultursubstraten und Pflanzenhilfsmitteln), substrates for green roofs are to be classified as growing media. The specifications of the DüMV regarding the emission limit values and the declaration of the contents must be observed.

Other regulations, e.g. LAGA M20 (Anforderungen an die stoffliche Verwertung von mineralischen Abfällen, Merkblatt 20, Bund/Länder-Arbeitsgemeinschaft Abfall) oder Bundesbodenschutzverordnung (BBodSchV) are concerned with waste law or soil protection and are therefore not suitable for the assessment of substrates.

## **7.12 Plant compatibility/phytotoxic safety**

The substances may not contain plant-damaging components. If phytotoxic properties are suspected, a germination test and/or a test for plant damaging gaseous substances is to be carried out.

---

## 8 Structural Requirements

---

### 8.1 General information

Structural requirements in relation to green roofs mainly refer to:

- protection against falling (see section 7.7);
- root barrier (see section 8.2);
- protection against damage to the waterproofing/root barrier membrane (see section 8.3);
- protection against efflorescence (see section 8.4);
- drainage facilities (see section 8.5);
- intersections (see section 8.6);
- protection against emissions (see section 8.7);
- protection against negative wind pressure (see section 8.8);
- fire prevention measures (see section 8.9);
- protection against material displacement (see section 8.10);
- edging (see section 8.11);
- Accessible surfaces (see section 8.12);
- furnishings (see section 8.13);
- solar panels (see section 8.14);
- tree supports (see section 14.3).

### 8.2 Root barrier

#### 8.2.1 Materials

Root penetration barriers can consist of:

- Membranes;
- full surface coating / liquid sealant.

Due to their construction, roofs made from waterproof concrete and welded metal sections are resistant to root penetration. Expansion joints in roofs made from waterproof concrete have to be specially treated against root penetration.

The root penetration barrier can be formed by an additional root penetration membrane above the roof waterproofing or, if suitable, by the roof waterproofing itself, provided that the requirements of section 8.2.2 are met.

## 8.2.2 Requirements

A functional barrier is required for both intensive and extensive green roofs to provide suitable and lasting protection for the waterproofing against root ingress or penetration.

Proof of root penetration resistance is to be provided in accordance with the FLL-"Verfahren zur Untersuchung der Wurzelfestigkeit von Bahnen und Beschichtungen für Dachbegrünungen" (see appendix C).

The use of plants with strong rhizome growth should be critically examined during planning. In the case of corresponding bamboo and Chinese reed types, constructional precautions beyond the root penetration barrier must be taken and special maintenance measures provided.

## 8.2.3 Implementation

From a waterproofing perspective, the waterproofing of a roof surface that is divided into various sub-areas should be protected in its entirety against root penetration.

Any transition points, roof penetrations and joints must be made resistant to root penetration.

A root barrier membrane in an area only provides root penetration resistance if a material-appropriate joining of the seams takes place. Depending on material properties, an additional sealing of the seam joints according to the manufacturer's instructions may be necessary in order to, e.g. close any existing capillaries in web-reinforced membranes.

When laying special root barrier membranes on rough surface conditions of a roof waterproofing, a protective ply to prevent mechanical damage to the root barrier membrane is required. Non UV-resistant waterproofing/root barrier membranes must be protected in freely weathered areas. The root barrier must not be damaged during the course of construction. In the event of an interruption in construction, a temporary protective measure in accordance with DIN 18531 or ZVDH/HDB "Fachregel für Abdichtungen – Flachdachrichtlinie" must be provided.

The formation of transition points must be carried out in accordance with the ZVDH/HDB "Fachregel für Abdichtungen – Flachdachrichtlinie" or DIN 18531. This also applies to root barrier membranes/layers laid in addition to the roof waterproofing. Root barrier membranes/layers laid in delimited areas are to be mechanically fastened in the upper transition area and, if necessary, protected against external influences.

In accordance with DIN 18531-3, DIN 18532-1 and 18533-1, expansion joints must be kept free of greening and made accessible where necessary.

In the case of area water accumulation (see section 9.4) where the waterproofing is not root-resistant, the root barrier can also form the water trough. In the case of root-resistant waterproofing, a water trough should be formed separately.

On roofs with a pitch of more than 10°, root-resistant waterproofing is preferable to laying a separate root barrier to minimize the number of possible sliding layers. If installation of a separate membrane is required, the positional security is to be ensured.

## **8.3 Protection against damage to the waterproofing/root barrier membrane**

Protective measures, protective plies and protective layers serve to protect the roof waterproofing/root barrier against damage.

### **8.3.1 Materials**

Protective plies used for green roofs can consist of:

- geotextiles;
- synthetic membranes;
- synthetic granulate mats or membranes;
- drainage mats and panels;
- insulation panels (e.g. for inverted roofs).

Protective layers under high stress, e.g. driving on the surfaces during the construction phase, can consist of:

- concrete;
- poured asphalt.

### **8.3.2 Requirements**

Protective layers and protective plies must be adapted to the dimensioning and compressive strength of the insulation/waterproofing as well as the load and use.

- In the case of green roofs, the following minimum requirements, following and supplementing DIN 18531-1 and 2 or ZVDH/HDB Flachdachrichtlinie [Flat Roof Guideline], for protective plies apply:

Geotextiles: area density at least 300 g/m<sup>2</sup> and 2 mm thick;

In addition, geotextiles must at least have the Geotextile Robustness Class (GRK) 2 in accordance with the " Merkblatt über die Anwendung von Geokunststoffen im Erdbau des Straßenbaus" [Leaflet on the Use of Geosynthetics in Earthworks in Road Construction]. A higher GRK may be required if higher loads during construction or use can be expected.

For thinner products or products with lower area density, their functionality may need to be proven.

- Protective construction mats or panels made of rubber granulate: nominal thickness 6 mm;
- Protective construction mats or panels made of plastic granulate: nominal thickness 4 mm.

Further note:

- Materials for protective plies and protective layers must be compatible with each other and with the structural waterproofing and be resistant to the mechanical, thermal and chemical stresses imposed on them;

- Materials must be resistant to rotting caused by the substances and microorganisms occurring in the planting structure for the given service life. Manufacturer's instructions are to be observed;
- Protective plies and protective layers may not be impaired by harmful foreign substances;
- Protective plies and protective layers may not contain foreign metallic substances from the production.

### 8.3.3 Implementation

When installing protective plies or layers, the waterproofing or root barrier membrane must not be damaged and dirt around the seals must be removed beforehand.

For loosely laid and overlapping protective plies or layers, it must be ensured that an overlap of at least 10 cm is achieved. If materials are butted together, an additional trickle barrier is necessary.

If the immediate covering of the products is not possible, the weathering resistance must be observed according to the manufacturer's instructions.

Protective plies and layers must be secured immediately after application, depending on the type of material.

The additional loads caused by protective layers of concrete, cement screed or poured asphalt must be taken into account.

Installation of cement-bound protective layers and/or lack of post-treatment may result in the risk of carbonates being leached out and drainage equipment being damaged (see section 8.4).

For protective layers of poured asphalt, the temperature and material compatibility must be taken into account.

On rising structural elements, roof edges and roof penetrations, the protective layer must be raised in order to also protect the waterproofing at these points. In doing so, the protective layer is installed up to just below the upper edge of the building material, which is installed in the marginal area. The waterproofing above is to be protected through separate measures, e.g. flashing.

Protective plies or protective layers are to be installed on surfaces and on rising structural elements in such a way that bulk materials cannot penetrate into underlying plies/layers, e.g. by:

- securing the overlap;
- increasing the minimum overlap;
- installation of bulk materials in the direction of the overlap;
- maintaining a minimum distance to the edges during pneumatic conveying.

## **8.4 Protection against efflorescence**

Damage caused by efflorescence in drainage facilities is generally not due to the layer structure of green roofs. The use of lime-rich vegetation strata, e.g. consisting of substrates with traces of mortar from recycled bricks, travertine, dolomite or calcareous composts, does not demonstrably lead to efflorescence in drainage facilities. The cause of damage was usually the dissolution of carbonates from concrete or cement screed protective layers and in individual cases from mortar or lean concrete haunching of edgings, surfaces or fixtures and fittings.

The installation of calcareous bulk materials, e.g. as recycled concrete or chalk aggregate, in drainage layers, marginal/safety strips or for design aspects, that can lead to efflorescence in the drainage facilities is inadmissible.

If protective layers of concrete or cement screed are used, their surface must be formed or treated so densely that only small amounts of carbonates can be leached out which do not lead to efflorescence.

For edgings (see section 11), walk-on surface layers (see section 8.12) and fixtures and fittings (see section 8.13) set in mortar, the type or surface treatment of the mortar shall preclude carbonates from being leached out to a greater extent.

If the regular installation of concrete, cement screed or mortar is not possible on a specific object, the surface must be protected from water by painting or covering or enclosing it with foils to protect it from leaching carbonates.

## **8.5 Drainage facilities**

### **8.5.1 Types**

Drainage facilities consist of:

- roof outlets;
- interior conduits;
- gullies in front of doors;
- guttering;
- spouts;
- emergency overflows.

### **8.5.2 Requirements**

Drainage facilities must be capable of collecting and removing both excess water from the drainage course and surface water from the vegetation layer. Water from adjoining façades and sealed surfaces has to be removed in such a manner that the structure of the vegetation layers is not impeded.

Where pressurized drainage is used, it must be determined during the planning phase on a site-by-site basis how effective the operation will be under the conditions found on a green roof (see section 7.8).

Roof drains and emergency overflows must not be allowed to become covered with greenery or loose material, e.g. gravel, and must be made permanently accessible. Gutters must not be overgrown and thereby functionally impaired.

### **8.5.3 Implementation**

#### **8.5.3.1 Roof drains in vegetation areas**

Where roof drains are located within vegetation areas, an inspection chamber will need to be installed to prevent fouling and overgrowth. Roof drains can be protected and optically marked by stone edging and/or gravel. Inspection chambers must not be an obstacle to drainage

If water retention is planned through ponding in the drainage layer, inspection shafts must be used to protect the roof drain with built-in flood control.

#### **8.5.3.2 Roof drains outside vegetation areas**

Roof drains outside vegetation areas are usually positioned openly in a gravel strip. To protect against clogging, they must be provided with a filter screen with meshing matched to the particle size of the surrounding gravel. Drains in walk-on areas are to be provided with a removable grid, which lies flush with the surface of the surface material.

#### **8.5.3.3 Emergency overflows**

The flow to the emergency overflows must not be hindered by the layer structure of the green roof or, e.g. through edging. The vicinity of emergency overflows must be designed so that the water can flow away unhindered and a visual inspection is possible at any time. They must be kept free from vegetation.

#### **8.5.3.4 Drainage on sloping roofs**

The drainage of sloping roofs takes place via gravel strips with and without embedded drainage pipes or via external or internal gutters or roof spouts. The difference between eaves drainage and valley drainage must be recognised.

With the increasing pitch of a roof, more surface runoff water is to be expected in the area of the eaves. This must be taken into account when dimensioning the drainage and the formation of eaves. Vigorous, overhanging vegetation is to be avoided around the eaves.

When draining roofs over a valley, the dimensioning of the drainage is especially critical, since two roof surfaces must be drained via the valley.

## **8.6 Transition points**

### **8.6.1 Types**

A distinction is made between transition points according to location:

- rising structural elements;
- doors;
- barrier-free transitions;
- roof penetrations;
- roof edges.

At the intersections of green roofs, the adjacent areas (marginal/safety strips, vegetation stratum, hard surfaces) must be observed in addition to the waterproofing aspects.

### **8.6.2 Requirements**

Transition points can be formed in different ways depending on the object, the particular detail and the material-specific features. In the ZVDH/HDB "Fachregel für Abdichtungen – Flachdachrichtlinie" and other waterproofing regulations, technical details are presented.

#### **8.6.2.1 Transition heights**

The transition points of roof waterproofing/root barrier membranes with other elements must be raised up, permanently secured and protected against damage in accordance with the ZVDH/HDB "Fachregel für Abdichtungen – Flachdachrichtlinie", DIN 18531-1 and DIN 18531-3.

The minimum heights for raising the roof waterproofing/root barrier membrane over the surface of the surface layer, e.g. gravel, slabs, vegetation stratum, should be:

for transitions to rising structural elements

- up to 5° roof pitch at least 15 cm;
- over 5° roof pitch at least 10 cm;

at transitions on free roof edges

- up to 5° roof pitch 10 cm;
- over 5° roof pitch 5 cm.

In snowy areas, a greater transition height may be required.

### **8.6.2.2 Marginal strips**

The marginal strip on green roofs is usually, mostly vegetation-free, e.g. gravel, aggregate or slabs, and forms a space between the transition and the vegetation area. The marginal strip serves the visual inspection of the waterproofing, the edge of the roof and rising structural elements.

The marginal strip can be designed as a safety strip against wind suction, whereby the width, the area load and the wind blow protection is to be specified during planning (section 8.8).

If the marginal strip is to function as a safety strip for preventive fire protection, it must be designed in accordance with the requirements of DIN 4102-4 (section 8.9).

If bulk materials are used, they should consist of particle sizes 16/22 to 16/32 unless otherwise specified. They may have particles  $\leq 8$  mm of at most 5% by mass,  $<0.063$  mm at most 3% by mass. In the case of bulk materials consisting mainly of rounded particles (e.g. river gravel), proportions of cracked particles do not represent a defect.

### **8.6.3 Implementation**

#### **8.6.3.1 Transitions to rising structural elements**

At transitions with façades and rising structural elements, the marginal strip serves as a safety strip and splash protection. It must be passable for inspection, maintenance and care work. The spacing to the vegetation prevents plants from growing in behind the waterproofing connection and from being impaired in their development by water running off the façade or dripping. If the strip has to be used for cleaning the façade, it has to be made correspondingly wider.

The edge of the roof waterproofing/root barrier membranes shall be fixed above the surface of marginal strips, vegetation areas and accessible coverings in accordance with the requirements specified in section 8.6.2.1.

If vegetation areas are created at a distance from the façade, different construction options are available:

- continuous drainage layer and, if necessary, filter layer under the vegetation stratum and marginal strip;
- vegetation stratum and margins next to each other without edging or separated by embedding, e.g. perforated plates.
- demarcation and separate drainage of vegetation stratum and margins;
- Installation of drainage channels instead of the marginal strip.

### **8.6.3.2 Transitions to doors with barrier-free transitions**

Barrier-free transitions on patio doors require lower connection heights and require special measures to prevent the ingress of water or water running behind the roof waterproofing.

The basic requirement is faultless water drainage in the immediate door area.

Further information, in accordance with the ZVDH/HDB "Flachdachrichtlinie", is:

*"Barrier-free transitions require special waterproofing solutions that have to be coordinated between planners, door manufacturers and contractors. The seal alone cannot ensure waterproofness at the door intersection.*

*Therefore, additional measures, such as.*

- *channel-shaped drainage grate or a comparable construction, heatable if necessary, with direct connection to the drainage,*
- *slope of the water-bearing level away from the transition to the roof surface,*
- *driving rain and splash protection through roofing,*
- *door frame with flange construction,*
- *doors with special sealing function,*
- *additional waterproofing in the interior with separate drainage,*
- *may also be required in combination."*

### **8.6.3.3 Roof edging**

In the case of a low attic height or higher vegetation strata, the vegetation area must be set back and demarcated with edging in order to comply with the prescribed transition heights (see section 8.6.2.1). The drainage of the vegetation area and the edge of the roof must be ensured. The same applies to roof edges with gutters.

If the waterproofing leads over the edge of the roof ends into the soil, a permanently watertight and possibly root-resistant connection to the wall waterproofing is required. According to ZVDH/HDB "Fachregel für Abdichtungen – Flachdachrichtlinie", the waterproofing must be secured at least 20 cm below the intersection between the deck and the walls and, if necessary, connected to existing wall waterproofing.

## **8.7 Protection against emissions**

Ventilation and air conditioning systems can cause frost and dry damage to plants due to the escape of hot and cold air and the occurrence of air currents. Emissions from chimneys and fumes emitting, e.g. SO<sub>2</sub>, can cause direct damage to the vegetation, especially to winter and evergreen plants. Therefore, in the area of impact of hot air, air currents and exhaust gases, special care should be taken to determine whether and, if so, which vegetation is suitable.

## **8.8 Protection against negative wind pressure**

Due to the effects of the wind, structures are subjected to pressure, suction and friction forces, the intensity of which depends on the wind direction and the shape and height of the building. The wind loads occurring in the roof area can cause damage to the roof structure during construction as well as in a finished condition. Protection measures for the roof water-

proofing and the layers belonging to the roof structure against lifting due to wind loads, must be pre-defined during the roof planning phase.

According to DIN EN 1991-1-4, roof areas are divided into different areas according to their different levels of wind stress. In particular, the ridge, corner, and edge areas are exposed to higher loads. They are to be secured by appropriate measures.

If the roof waterproofing and root barrier are loosely laid, they must be secured against lifting wind forces by the layer structure of the green roof. In edge and corner areas, e.g. bulk gravel material and in higher load areas slabs, should be installed. During construction, temporary safeguard measures are required.

In general, when constructing green roofs, the aim is to keep the load and the height of the layer structure as low as possible, it may be necessary to secure the particularly vulnerable edge and corner areas by increasing the layer thicknesses or by using heavier materials. The load of the layer structure in a dry state is decisive here. If necessary, the securing of the edge and corner areas must be carried out in combination with, e.g. gravel, grass stones or slabs.

The load required for securing can be calculated in accordance with DIN EN 1991-1-4 and in conjunction with the corresponding partial safety factors according to DIN EN 1990. Information on the safeguarding of roof waterproofing against lifting by wind forces can also be found in the ZVDH/HDB "Fachregel für Abdichtungen – Flachdachrichtlinie".

These requirements, based solely on the weight of gravel or concrete slabs, do not take into account that additional positive factors are effective for green roofs:

- the roughness of the vegetation;
- the load of residual moisture in the layer structure;
- the load of the vegetation stock;
- the fixation of a large area though extensive root penetration of the entire layer structure in comparison to the single-particle composition of a gravel layer;
- The wind permeability of the vegetation stratum, which leads to a pressure equalization between the top and bottom of the layer and thus to a load reduction.

For the design according to DIN EN 1991-1-4, the aerodynamic coefficient for the external pressure  $c_{pe}$  10 can be used.

## 8.9 Fire prevention measures

With regard to fire prevention measures, the demands made on roofs in state building regulations mean that they must be sufficiently resistant to fire exposure from the outside due to flying sparks and radiant heat ("hard roofing") (MBO § 32 (1)), otherwise a number of constraints, in particular greater distances to adjacent buildings (MBO § 32 (2)) must be adhered to.

In DIN 4102 Fire behavior of building materials and building components - Part 4: Synopsis and application of classified building materials, components and special components, green roofs are classified as "roofs are resistant to flying sparks and radiant heat" if they have the following characteristics:

*"(1) Intensive green roofs are considered as roofs that are resistant to flying sparks and radiant heat.*

*(2) Extensive green roofs are resistant to flying sparks and radiant heat if they have the following characteristics:*

- *mineral-rich vegetation layer with max. 20% (by weight) of organic constituents;*
- *Vegetation stratum with a layer thickness  $\geq 30$  mm*
- *Façade walls, firewalls or walls that are permissible instead of firewalls must finish, at intervals of not more than 40 m, at least 0.3 m above the roof, relative to the top of the vegetation layer. If these walls do not finish above the roof, a 0.3 m high upstand of non-combustible building materials or a 1 m wide strip of solid slabs or coarse gravel is sufficient;*
- *a spacer strip of solid slabs or coarse gravel  $\geq 0.5$  m wide shall be formed around openings in the roof surface (domed rooflight, skylights) or to rising walls with windows, if its balustrade is  $\leq 0.8$  m above the vegetation stratum;*
- *In the case of aligned, gable-ended buildings, a horizontal strip of at least 1 m wide strip must remain un-greened along the eaves and provided with surface protection made of non-combustible building materials. "(DIN 4102-4 2016, para. 11.4.7, p. 197)".*

In addition, during construction and use, general rules of fire prevention must be observed, such as:

- Construction phase;
  - orderly construction site conditions;
  - no storage or rapid disposal of packaging material;
  - quantity and time limited storage of building materials according to construction progress;
  - decentralized storage of building materials such as waterproofing membranes and geotextiles;
  - careful handling of open flames and other heat sources (e.g. gas burners and hot air welding equipment for laying membranes, grinders).
- Use
  - maintenance of the defined condition "hard roofing" through appropriate care and maintenance (e.g. watering, removing dried plant parts, keeping spacer strips free of vegetation);
  - make any necessary changes in case of a change of use from the defined state "hard roofing";
  - no control of unwanted vegetation by means of heat appliances (e.g. gas burners, hot air devices, infrared devices);
  - careful handling of open fire and other heat sources (for example: garden grill, campfire, radiant heater).

## 8.10 Protection against material displacement

### 8.10.1 Types

Fundamentally, three forms of material displacement are to be differentiated between for green roofs, for which different safeguarding measures are partly necessary. These include:

- surface erosion (see section 8.10.1.1);
- slipping of layers at a layer boundary (see section 8.10.1.2);
- material displacement when the bulk angle of repose is exceeded (see section 8.10.1.3).

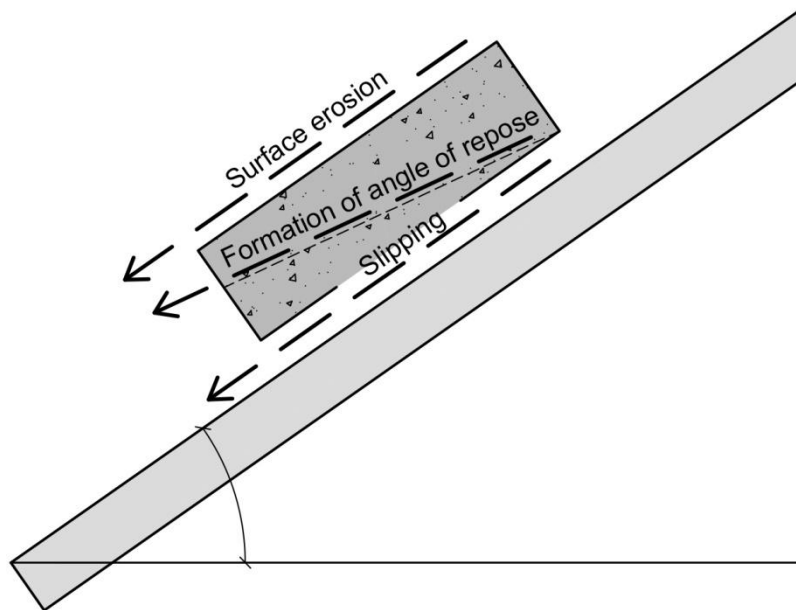

**Figure 1:** Schematic representation of surface erosion, slipping and exceeding the angle of repose

Depending on the exposure, measures against surface erosion may be required for roofs with a pitch of as little as  $0^\circ$ . Measures against slipping may be required as of  $10^\circ$ , depending on the design or construction. Dependent on the substrate, measures may be required against exceeding the angle of repose.

#### 8.10.1.1 Surface erosion

Surface erosion can occur on both sloped and flat roofs. In particular, wind and water attack during the production of green roofs is a threat to the vegetation stratum, the sprouts and the seed. The period of danger is shortened by the introduction of vegetation in a favorable season for the vegetation development.

Until the layer structure is fixed by the infiltration of the roots of the vegetation, there is a risk to the vegetation stratum, plants and seeds by exposure to water and wind.

To counteract damage,

- special requirements for the layer structure (choice of material, chippings of hard rock as a mulching layer);
- temporary effective measures (erosion control fabric, soil stabilizer, keep damp);
- as well as special measures for extreme locations (wet sowing, vegetation mats)

may be necessary, some of which may be combined (see sections 8.10.2 and 8.10.3).

The risk of erosion of substrates by wind is not to be judged by the wind speed, but by the material-related rate of drift.

In the case of pitched green roofs in a sun-exposed position, in addition to erosion protection affected by the vegetation, irrigation may be necessary at times along with a nutrient supply.

### 8.10.1.2 Slipping of layers at a layer boundary

The risk of slippage of the vegetation structure or of individual layers on pitched roofs exists at each layer boundary and depends on the friction between the materials. Depending on the design or construction, safeguarding measures may be necessary above a pitch of 10°. Optimization options include reducing the number of layers or using composite elements (e.g. drainage elements with bonded protective geotextiles).

To prevent slipping, the following measures can be implemented:

- increasing the friction by matching the materials to each other;
- constructive support at the eaves;
- constructive suspension at the ridge;
- constructive measure in the roof area (e.g. shear ties).

### 8.10.1.3 Material displacement when the bulk angle of repose is exceeded

Displacement of bulk material occurs when the natural angle of repose of the material is exceeded during installation or in the long term. On sloping roofs, this is problematic if the maximum angle of repose is smaller than the roof pitch (see Fig.: 2).

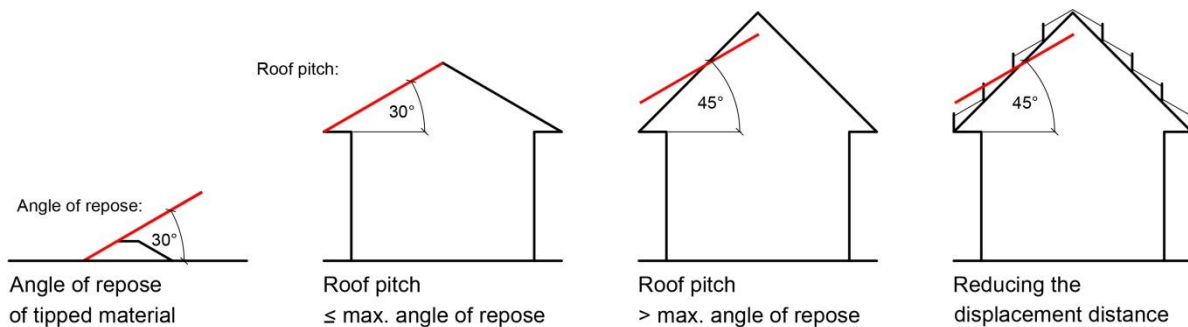

**Figure 2: Surface formation of the substrate as a function of angle of repose, roof pitch and when installing shear ties**

**Note:** See table 1 for a comparison of % fall and ° pitch.

The resulting possible surface slope depends on the substrate and cannot be influenced by measures against slipping. Structurally stable substrates can be installed on surface slopes of up to 30° without additional measures (see 2).

To avoid the displacement of bulk material above the maximum angle of repose, the following measures are possible:

- Increasing the shear strength in the bulk material (e.g. plant-compatible adhesives, fibers or vegetation);
- Reduction of displacement distances (e.g. grid, chamber or honeycomb systems);
- Bundling bulk materials in (e.g. wire-mesh boxes, textile bags, cassettes);
- Surface coverage (e.g. through fabric-reinforced vegetation mats).

Alternatively, bulk-material-free constructions can be used.

### **8.10.2 Material properties**

In order to protect against surface erosion, in particular against negative wind pressure on flat roofs and on sloping roofs, structurally stable growing media with higher individual particle weights (particle size/density) can also be used in the dry state. Further structural stability (against surface erosion and exceeding the angle of repose) can be achieved by intermeshing particle shapes in the fine and medium gravel range as well as small amounts of elutriates and organic matter.

Areal materials are to be matched in their friction properties.

Constructive measures of whatever form, e.g. statically effective connected mesh mats, ties, grid profiles, studded panels, fabrics and their fasteners must be durable and weather-resistant. They must not hinder the vegetation development. Degradable materials (such as wood) should be excluded as a permanent safeguard.

The tensile strength of geotextiles or geotextile composites and, where applicable, their fasteners shall be designed for the static loads. In addition, the snow load must also be taken into account.

Anti-erosion fabrics must remain functional until the completion care has been carried out.

Plant species and vegetation and cultivation forms should be suitable for the site as well as enable a quick and permanent area coverage.

### 8.10.3 Manufacture

Irrespective of the pitch, measures can be necessary to protect against water and wind erosion on all roof surfaces until the root system has developed. Pre-cultivated vegetation mats, dense vegetation, erosion protection fabrics, wet seed plants, sprouting seeds in combination with mulch and glue can be used here. If wind erosion is to be expected, it is also possible to keep the vegetation substrate constantly wet during the completion care.

In the case of (wind) erosion-prone substrates, greening with vegetation mats or turf stones should be carried out on the roof edges and on particularly vulnerable sub-areas.

For roofs with a slope of more than 3°, additional measures can be necessary, according to DIN 18531-3 and the ZVDH/HDB "Fachregel für Abdichtungen – Flachdachrichtlinie", such as bonding of the roof waterproofing, installation of support structures and mechanical fastening to prevent slipping of the layer package.

In order to reduce the sliding layers on roofs with a roof pitch of more than 10°, penetration-proof waterproofing is preferable to a separate waterproofing and root barrier membrane. If in exceptional cases this cannot be guaranteed, the positional security of the root barrier membrane must be ensured and proven.

Above a roof pitch of 10°, safeguarding measures against slipping are required. These measures may, in the simplest embodiment, consist of drainage elements, if in the form of rolled material and having the tensile strength, being placed over the ridge or attached to it. If the construction is inherently rigid, the drainage elements can be supported on the eaves. It must be determined that the ridge and/or eaves can bear the resulting loads and the required attachment is sufficiently strong. Loosely laid geotextiles above drainage elements should be avoided above this pitch.

For roofs with an inclination of 20° and above, a reduction in the number of sliding layers is necessary and construction methods with loosely laid geotextiles should be avoided, i.e. these roofs can be constructed in single-layer format or with drainage elements without geotextiles.

Furthermore, at this roof pitch and above, erosion protection must be ensured directly and independently of exposure.

For roofs with a pitch of more than 30°, there is a risk of slipping as well as a displacement of bulk material. For measures against slipping at this pitch and higher, a separate static calculation is required. The load transfer to constructive safety elements, eaves and other roof installations must be proven. Manufacturers of constructive safeguarding elements should provide appropriate structural calculations or calculated values. The safeguarding measures must not add additional tension to the waterproofing/root barrier.

Measures against the displacement of bulk material according to paragraph 8.10.1.3 may be used for slopes of 30° and above. If none of these safeguarding measures is implemented, the client must be informed of the possibility of displacement.

Green roofs on roofs with a slope of more than 45° should be avoided due to the increasing risk of slipping and displacement of bulk material.

**Table 2: Measures to prevent material displacement on flat and pitched roofs depending on the roof pitch.**

No.	1	2				
		pitch				
1	Possible measure	≥ 0°	≥ 3°	≥ 10°	≥ 20°	30-45°
2	<b>Measures against surface erosion from 0° pitch</b>					
3	Temporary measures to protect against water and wind erosion until vegetation acceptance is possible	X	X	X	X	X
4	Greening with vegetation mats or turf stones at areas at risk from wind	X	X	X	X	X
5	<b>Measures for fixing the waterproofing from 3° pitch</b>					
6	Fixing the roof waterproofing in accordance with DIN 18531-3 and the specialist rule for waterproofing (ZVDH/HDB)		X	X	X	X
7	<b>Measures against slipping from 10° pitch</b>					
8	Use of root-resistant roof waterproofing (no separate installation of root barrier membrane)			X	X	X
9	Safeguarding against slipping			X	X	X
10	No loosely laid filter fleece above drainage elements			X	X	X
11	Immediate measures for erosion protection (vegetation mats, wet spraying with glue, erosion protection fabric)				X	X
12	No loosely laid filter geotextiles for all types of construction				X	X
13	Safeguarding against slipping with static proof					X
14	<b>Measures against surface erosion from 30° pitch</b>					
15	Measures against material displacement recommended					X

## 8.11 Edging

### 8.11.1 Types

Edging can consist of:

- rising structural elements;
- locally manufactured components, e.g. from wood, brick, in-situ concrete;
- prefabricated components, e.g. from concrete, fibre cement, wood, plastic, lightweight concrete, metal, stoneware.

### 8.11.2 Requirements

Edging must be stable. There must be no pressure from the corners on the roof waterproofing/ root barrier membrane. The pressure distribution at the point loads and the compressive strength of the thermal insulation material must be observed.

### 8.11.3 Implementation

The installation of locally manufactured components or prefabricated components can take place either on a protective ply and/or on sliding plies directly on the roof waterproofing/root barrier membrane or over a continuous drainage layer. In the case of chemical incompatibility, a separate separating ply may also be required, provided this task is not already fulfilled by the protective/sliding ply.

Pre-fabricated components should be set in plastic-coated mortar or fine-particle aggregate to avoid washing out. Please refer to section 8.4. Depending on the arrangement of the roof drains and where a common drainage of both vegetation and hard surfaces is planned, water outlets are to be provided at the base of the edging, unless a separate drainage of the partial areas takes place.

## 8.12 Accessible surfaces

**Note:** For paths and driveways for rubber-tired vehicles, see FLL "Empfehlungen zu Planung und Bau von Verkehrsflächen auf Bauwerken" – see also section 1.1.

### 8.12.1 Types

Accessible surfaces can be made of:

- materials laid in fine gravel, e.g. slabs of concrete or natural stone, brick setts, concrete or natural stone;
- raised surfaces, e.g. panels or wooden grates.

The drainage of the surfaces can be done by:

- a surface fall to the roof drains;
- joint infiltration into a continuous drainage layer;
- Joint drainage between raised surfaces.

### **8.12.2 Requirements**

Surfaces must be stable and not under tension. The roof waterproofing/root barrier membranes must not be impaired in their function through occasional corner pressure of the surface material. The point loads of raised surfaces are to be adjusted to the ground below.

Butted surface materials laid in fine split must be laid with sufficient surface fall.

Due to the risk of efflorescence, cracking, freezing and staining, pavements laid in mortar should only be used in exceptional cases - see section 8.4.

### **8.12.3 Implementation**

Surface materials laid in fine gravel must be laid on the filter layer above a continuous drainage layer or directly in drainable building materials.

For raised surface material, depending on the design of the pedestal support, a pressure-distributing layer is required. Drainage layers of vegetation areas can be dewatered in or through the pedestal supports.

When irrigating the vegetation areas by water ponding, a separation must be made between vegetation areas and areal surface materials. The thickness of the drainage layer of loose materials under loosely laid surface materials should be  $\geq 6$  cm.

## **8.13 Furnishings**

### **8.13.1 Types**

Furnishing elements are e.g.:

- trellises;
- pergolas;
- lamps;
- pools.

The arrangement and design of furnishing elements are object-specific, detailed solutions that are to be solved structurally, statically and physically on a case by case basis.

### **8.13.2 Requirements**

Furnishing elements must be stable, load-distributing and, if necessary, anchored. The tensionless positioning on the ground is of particular importance. The occurring point and/or area loads as well as the wind loads are to be taken into account.

### 8.13.3 Implementation

The attachment of furnishing elements can be done by:

- load-distributing anchoring on the roof with constructive pre-installation or
- flat or grid-like foundations (see section 8.4).

The constructive pre-installation is possible with foundations lifted above of the waterproofing level. In addition to the static requirements, the specifications for the formation of roof penetrations must be observed (see section 8.6).

Constructive retrofitting should be the exception. Roof waterproofing/root barrier membranes and thermal barrier layers with vapor barriers must not be broken. The formation of flat or grid-like foundations requires the application of a sliding and protective layer over the underlying layers of the roof structure. The dimensioning depends on the type of furnishing and the effect.

The subsequent manufacture of roof penetrations for the anchoring of components, which are to be provided for the use of the roof space, should be avoided as far as possible. If constructive foundations for anchorage were not planned, it is necessary to check whether construction and furnishing elements, e.g. pergolas, trellis, lamps and benches, can be anchored to overlying and load-distributing foundation plates or grid foundations.

### 8.14 Solar panels

Solar panels are photovoltaic systems for power generation or solar thermal systems for the production of heat energy.

Green roofs and solar systems can be combined, especially on flat roofs. Synergy effects can occur in electricity generation, because the low surface temperature of the greening, compared to freely weathered or gravelly roofs, leads to a lower heating of the photovoltaic modules and thus to increased efficiency.

Restrictions in the combination of solar systems and green roofs can be, e.g. by shading the vegetation with flat and close together rows of solar modules. Here, it should be checked during the planning whether it makes more sense to assign the greening and the solar panels to separate roof areas.

When planning photovoltaic systems, it must be ensured that the modules are not shaded by the vegetation. For this purpose, attention must be paid to a sufficient distance of the lower edge of the modules to the substrate, depending on the height of the vegetation. The minimum distance for a low-growing extensive greening should be 20 cm and may be higher, depending on the planned vegetation.

Solar systems can be fixed with or without penetration of the roof skin. If they are to be mounted without penetration of the roof skin, the weight of the green roof structure can serve as a load for attachment. Structural requirements regarding the wind loads as well as the building construction are to be considered.

Since solar energy systems and green roofs require regular maintenance and care, maintenance routes and fall protection systems must be provided (see section 7.7). It is important to ensure a sufficient distance from the edge of the roof and a distance between the module rows. Cables and other components belonging to the solar energy system are to be mounted in such a way that maintenance and care (e.g. plant cutting) are possible without any problems.

Due to the solar energy systems, changing site conditions arise on the roof due to different solar radiation and moisture conditions. These can also contribute to increasing biodiversity of flora and fauna (see section 9.5).

In order to obtain sufficient light incidence, even from diffuse light, the distance of the module rows, the module depth, the height of the modules or the transparency of the module rows must be adapted to the vegetation.

With regard to the moisture conditions, solar energy systems generate a rain shadow for the vegetation area underneath on the one hand, on the other hand, rainwater flows off the front edge of the modules and the increased amount of water leads to a more humid location. This results in greater plant growth and can result in increased maintenance effort.

The water should therefore be directed to supply water to the vegetation below the modules in the rain shadow.

---

## **9 Requirements for the construction of vegetation areas**

---

### **9.1 Functional layers**

A differentiation is made between the following layers:

- vegetation stratum;
- filter layer;
- drainage layer;
- protective ply;
- root barrier membrane;
- separating ply;
- sliding ply.

### **9.2 Construction methods, layer thicknesses**

#### **9.2.1 Construction**

The structure of vegetation areas usually consists of several functional layers with material and structural differences, which are to be matched in their function to each other.

Depending on their material composition, individual layers can perform several functions.

A differentiation is made between the following construction methods:

- multi-layered construction methods, consisting of separately formed drainage, filter and vegetation strata or of a drainage and vegetation layer in which the filter function is taken over by the material composition;
- single-layered construction, consisting of a vegetation stratum with drainage and filter functions.

All constructions require a root barrier membrane and adequate protection of the roof waterproofing/root barrier membrane.

### 9.2.2 Layer thicknesses

The thickness of the layer structure depends on:

- the roof construction method;
- the desired type of greening and vegetation;
- the desired biodiversity in flora and fauna of the habitat;
- the material of the layers.

Table 3 shows the layer thicknesses of the different types of green roof.

When dimensioning the layer structure, the following is to be considered:

- the requirements of the vegetation;
- the properties of the materials used;
- the roof pitch;
- the exposure of the roof area;
- the regional climatic conditions;
- the object-related site conditions;
- the building-material-specific area loads;
- the desired water retention;
- ecological quality in terms of biodiversity.

In addition, when dimensioning the functional layers, it should be noted that

- as the thickness of the vegetation stratum increases, a differentiation must be made in the organic matter content;
- single-layer constructions from bulk materials should have a minimum thickness of 8 cm;
- to avoid waterlogging in thin layers, attention must be paid to a sufficient roof fall (see section 7.3);
- when dimensioning the drainage layer unfavorable drainage conditions, e.g. not enough roof fall, opposite fall, unevenness on the roof surface and roof drains that are too far apart, are also to be taken into account;
- dimensioning thicker drainage layers should also be based on the desired vegetation engineering expansion of the rootable volume and a high airflow, beyond the technical drainage requirements;
- special constructions have to be oriented towards the basic structural and technical vegetation requirements.

**Table 3: Thicknesses of different greening and vegetation types <sup>1)</sup>**

Rootable layer thickness in cm		4	6	8	10	12	15	18	20	25	30	35	40	45	50	60	70	80	90	100	125	150	200		
Type of greening and vegetation form	Extensive greening	Moss-sedum greening	█	█	█																				
		Sedum-moss-herbaceous greening		█	█	█																			
		Sedum-herbaceous-grass greening				█	█	█																	
		Grass-herbaceous greening						█	█	█	█	█	█	█	█	█									
	Simple intensive greening	Grass-herbaceous greening																							
		wild-perennial-shrub greening																							
		woody-shrub-perennial greening																							
		woody-plant greening																							
	Intensive greening	Turf																							
		Low perennials and woody plants																							
		Med. perennials and woody plants																							
		High perennials and woody plants																							
		Big shrubs and small trees																							
		medium-high and high trees																							
	High trees																								

<sup>1)</sup> The regional climatic conditions and the object-specific conditions, which in some cases differ considerably from one another, require a lesser or greater layer thicknesses within the illustrated ranges.

### 9.3 Water Retention

#### 9.3.1 General

The reduction of water runoff from rainfall, the plant-available storage of retained rainwater and the delay in the discharge of excess water are major effects of green roofs. They are of importance from an ecological, drainage and economic point of view.

The following parameters are used to identify this effect:

- maximum water capacity;
- water permeability;
- runoff coefficient, discharge delay;
- additional retention performance;
- annual runoff coefficient.

### 9.3.2 Maximum water capacity

The maximum water capacity is used to determine the water storage capacity of the materials used in the layer structure in a compacted state. The maximum water capacity describes the amount of water held by a water-saturated substance after dripping for two hours. It is used to characterize technical vegetation properties (see sections 10.2.6 and 12.2.8).

### 9.3.3 Water permeability

The water permeability mod.  $K_f$  of the materials used in the layer structure indicates the flow in the distance and time unit in a compressed and water-saturated state (see sections 10.2.5 and 12.2.7).

### 9.3.4 Runoff coefficient/runoff reference value/coefficient of discharge

In DIN EN 12056-3, the terms runoff coefficient  $C$  and runoff reference value  $C$  are used synonymously. In DIN 1986-100, the term runoff coefficient  $C_s$  (old designation  $C$  or  $\Psi$ ) is used for this purpose. The three different terms result from different issues of the standards and deal with the peak runoff coefficient. For the following, only the current term runoff coefficient  $C_s$  according to DIN 1986-100 (issue 12-2016) is used. In addition, the mean discharge coefficient  $C_m$  is used for the calculation of the volume of rain retention areas in DIN 1986-100.

The runoff coefficient  $C_s$  flows as a dimensionless parameter into the calculation of rainwater runoff (l/s).

When dimensioning the roof drainage, the ratio of the rainwater runoff to the rainfall of a block rain must be used as the runoff coefficient  $C_s$  for green roofs (see also attachment B.4 in appendix B).

For green roofs, the following orientation values can be used as runoff coefficients  $C_s$ , depending on the thickness of the bulk-material layer structure and the roof pitch, whereby the use of drainage layers with high drainage capacity can mean a deviation from the actual runoff coefficients, which are generally much higher:

Roof pitch up to 5°		Roof pitch greater than 5°
for > 50 cm layer thickness	$C_s = 0,1$	—
for > 25 – 50 cm layer thickness	$C_s = 0,2$	—
for > 15 – 25 cm layer thickness	$C_s = 0,3$	—
for > 10 – 15 cm layer thickness	$C_s = 0,4$	$C_s = 0,5$
for > 6 – 10 cm layer thickness	$C_s = 0,5$	$C_s = 0,6$
for > 4 – 6 cm layer thickness	$C_s = 0,6$	$C_s = 0,7$
for > 2 – 4 cm layer thickness	$C_s = 0,7$	$C_s = 0,8$

Through examination, location and/or product-specific values can be proven. Depending on local rainfall, higher or lower runoff coefficients may result.

The runoff coefficients determined according to the procedure described in the appendix (see also attachment B.4 in appendix B) are examined on un-greened construction methods and apply to the layer structure during a 15-minute design rainfall of  $r_{(15)} = 300 \text{ l/(s x ha)}$  after previous water saturation and draining for twenty-four hours. The vegetation and rooting affect a delay in discharge, so that for this 0.05 units are credited and then subtracted from the measurement result. For construction methods that can only be produced in advance, e.g. with vegetation mats, the additional units are not considered.

The values determined using the procedure for "Determining the runoff coefficient  $C_s$ /the runoff reference value  $C$ /the coefficient of discharge  $C$  (peak runoff coefficient)" are primarily used to calculate the drains and pipe diameters for the site drainage in accordance with DIN 1986-100.

As an alternative to the methods described above, location and/or product-specific values can be determined by simulation methods commonly used in urban water management. The values of the simulation methods also enable the calculation of pipeline networks in the field of urban water management.

### 9.3.5 Additional retention performance

To relieve the wastewater network and rivers, possibly also sewage treatment plants, it may be useful in the sense of urban water management to use the green roof areas as retention spaces beyond the usual extent. In the case of these "retention roofs", the water accumulates in the green roof structure, possibly also in an additional layer, and is stored temporarily. The discharge is throttled under defined conditions in volume and/or with a time lag.

When planning and building such a retention roof, pay attention to the following:

- such a retention roof represents a planned deviation from the usual drainage, this is to be pointed out during planning;
- the retained water must not lead to permanent waterlogging of the green roofs;
- the functionality of the drainage facilities above the desired storage volume as well as emergency drainage must be maintained;
- if the accumulation on the roof waterproofing is to take place, a non-sloping roof makes sense;
- the maximum amount of water is to be considered structurally in addition to the load of the layer structure at maximum water capacity;
- desired accumulation volume, maximum permissible water quantity per time unit as well as the period after which the accumulation volume must be available again must be planned;
- The waterproofing must be suitable for the particular load situation.

### 9.3.6 Annual runoff coefficient

The percentage of water retention as actual retention is determined as the difference between the amount of precipitation fallen and the amount of water drained on an annual average. Conversely, according to DIN 4045, the annual runoff coefficient  $\Psi_a$  is the ratio of the annual rainfall runoff to the annual rainfall. In wastewater fees with fee splitting, this is also recorded as a sealing factor.

The annual water retention depends on both the type of construction and the thickness of the structural layers. The material-specific water storage capacity on the one hand and water permeability on the other must be taken into account. Differences between the structural thicknesses and construction methods are more pronounced in summer weather conditions; they become increasingly equal in cool weather and are almost the same in wintry weather. Although the higher proportion of annual precipitation falls in the summer period, the water retention here is much higher, while in wintry weather with less precipitation, but also less evaporation of the layer structure and the lowest transpiration of the plants, the water discharge is highest.

In the following table, reference values for the percentage annual water retention are compiled. With regard to consideration of fee splitting in wastewater charges, the annual runoff coefficient/sealing factor is also reported.

**Table 4: Reference values for the percentage annual water retention and the annual runoff coefficient for green roofs depending on the structural thickness of bulk materials<sup>1)</sup>**

N0.	1	2	3	4
1	Type of greening	Structural thickness in cm	Annual average water retention in %	Annual runoff coefficient $\Psi_a$ / sealing factor
2	Extensive greening	2 – 4	40	0,60
		> 4 – 6	45	0,55
		> 6 – 10	50	0,50
		> 10 – 15	55	0,45
		> 15 – 20	60	0,40
3	Intensive greening	15 – 25	60	0,40
		> 25 – 50	70	0,30
		> 50	≥ 90	≤ 0,10

<sup>1)</sup> The figures refer to sites with 650 - 800 mm annual precipitation and investigations over several years. In regions with lower annual rainfall, water retention is higher and in regions with higher annual precipitation, water retention is lower.

## **9.4 Water storage and additional irrigation**

### **9.4.1 Water storage**

The vegetation development on green roofs is significantly influenced and limited by the water supply. If, for structural reasons and economic constraints, the load assumptions and structural thicknesses are to be kept as low as possible, the water storage space and thus the water supply are considerably reduced.

The water storage can take place in different layers and in different ways. Depending on the construction and arrangement in the individual layers, the following types of water storage are to be distinguished:

- in the vegetation stratum by using water-storing materials in the growing media and, if necessary, additionally in water storage panels or mats;
- in the vegetation stratum and additionally in the drainage layer by using particle-graded, open-pored bulk materials or prefabricated, draining, water-storage panels;
- in the vegetation stratum and additionally in the drainage layer by areal accumulation in bulk materials or under special drainage panels or partial accumulation in drainage profiled panels;
- and possibly additionally in water-storing protective layers and protective plies.

Simultaneous water storage in the vegetation stratum and drainage materials can be used in all types of green roof. The entire layer structure is intensively rootable space and is available for water storage.

In the case of intensive greening, the combination of water storage in the vegetation stratum with water accumulation in the drainage layer is an expedient form of water storage.

In simple intensive roof areas with a thin-layered construction, water accumulation in the drainage layer only makes sense if additional irrigation takes place in low-precipitation periods to avoid drought damage to the vegetation.

Ponding in extensive green roof areas brings with it disadvantages from a plant physiological point of view (see also section 7.3).

### **9.4.2 Additional irrigation**

The use of free and freely available rainwater forms the basis of the water supply to green roofs in order to minimize the need for additional irrigation and to introduce the rainfall directly back into the natural water cycle. Additional irrigation is regularly required for intensive greening if necessary and may be required for extensive greening during the completion care. For more steeply inclined roofs, the possibility of additional irrigation should be foreseen in order to avoid plant failures in extreme periods of drought thus avoiding the onset of erosion.

Additional irrigation can be performed with:

- hose;
- hose and sprinkler;
- spray hose;
- drip line;
- sprinkler system;
- Automatic irrigation system with water ponding.

Irrigation with sprinklers, spray hoses or drip lines can be done manually or via a timer. Corners and marginal areas that are not covered by the sprinkler, as well as areas that are not sufficiently irrigated because of roof coverage, water jet deflection or wind drift, must be watered by means of a hose.

Irrigation with above-ground or underground irrigation systems can be controlled manually, via a timer or fully automatically. The pipes must be corrosion-resistant and frost-proof, or completely emptyable, to prevent damage caused by frost.

Irrigation via water ponding can be designed with a semi or fully automatic water supply. The precipitation water is stored by accumulation in the drainage layer and the amount thereof depends on the type and thickness of the drainage layer. In order to exclude waterlogging of the vegetation stratum, a minimum distance of 2 cm must be maintained between the maximum water level and the filter layer and, if necessary, be made greater depending on the materials. During dormancy in the winter months, the water level should be set lower on the adjustable baffles in the roof drains or the water should be drained completely.

## **9.5 Biodiversity of green roofs**

Among the important ecological functions of green roofs, is the creation of reference areas and habitats for flora and fauna. High biodiversity on green roofs not only makes a significant contribution to compensate for the negative consequences of building and sealing to the natural resources of fauna and vegetation. Various scientific studies have shown that species-rich green roofs with different vegetation types also have positive effects on other ecological functions and effects, such as rainwater retention and runoff delay, cooling effects and pollutant filtering. The development of biodiversity on green roofs depends enormously on how the vegetation areas offered to the plants and animals are constructed. Through various design measures and the consideration of basic principles of biodiversity, a mosaic of different habitats can be created.

### **9.5.1 Materials/manufacture**

The highest faunistic biodiversity is found on green roofs with a high degree of structural diversity, such as in extensive greening with raised areas and woody vegetation and simple intensive greening. But even with intensively planted green areas, it is possible to integrate specific aspects of biodiversity. The biotope of a single animal species, which is particularly worthwhile protecting, can be recreated on the roof, if other aspects such as area size, spatial proximity to the target species and biotope networking are taken into account. In addition, it should be examined whether it is possible to connect the roof surface to the surrounding land (e.g. via greening of facades, joint-rich natural quarry-stone walls, gabions or embankments).

### **9.5.2 Implementation**

If green roofs are to be used as a compensatory or abatement measure in order to minimize the encroachment on the protected natural resources, the following building blocks of biodiversity must be applied:

- Selection of a substrate or various substrates with which the desired greening target or the desired habitat can be achieved;
- Modulation of the substrate surface with changing elevation;
- Creation of smaller, vegetation-free areas (e.g. in the form of sand or clay lenses, coarse gravel beds or mineral aggregate areas);
- Creation of frost-free retreat areas for ground animals through substrate mounding, woody plantings or higher plant beds.

In addition, depending on the degree of crediting of green roofs for compensation or abatement measures (see section 4), the use of local plant material (see section 13.2.1) which is appropriate for the respective site conditions may be planned.

Further complementary components are:

- Incorporation of insect and bird food plants into the planting concept;
- Introduction of dead wood (heap of branches, root stocks, tree grates);
- Use of windproof nesting aids for birds and insects;
- Placement of water elements, possibly with appropriate flora (e.g. water troughs, small ponds).

The biodiversity building blocks can be used both for new constructions and in the ecological upgrading of existing green roofs. A detailed plan for their compilation must be prepared, possibly with the involvement of biologists. Depending on the local flora and fauna and the nature conservation objectives at the respective location, it may be appropriate to include further measures. The above measures are therefore not an exhaustive list.

### **9.5.3 Maintenance**

In order to preserve biodiversity, the functionality of the biodiversity modules and habitats created must be regularly reviewed and, if necessary, maintained. The maintenance arrangements (see section 15) must therefore include references to the habitats created and their conservation.

---

## 10 Drainage Layer

---

### 10.1 Materials groups and types

When the drainage course is being formed, a distinction is made between the following groups and types of materials:

- Aggregates
  - gravel and fine chippings;
  - lava and pumice;
  - expanded clay and shale, broken and unbroken;
  - expanded slate, broken and unbroken.
- Recycling aggregates
  - tiles, broken;
  - slag;
  - foamed glass.
- Drainage matting
  - structured fleece matting;
  - studded plastic matting;
  - woven fibre matting;
  - foam matting.
- Drainage panels
  - studded rubber panels;
  - shaped rigid plastic panels;
  - shaped plastic foam panels.
- Drainage and substrate panels
  - panels made from modified foam.

The choice of material and the dimensioning of the layer depends on the structural requirements, vegetation engineering objectives and possible additional functions to be performed.

If certain products, such as drainage panels, show a characteristic value for thermal resistance as specified by the Construction Inspectorate, green roofs may be constructed with a calculable heat insulation effect.

Construction requirements relate to:

- the drainage function;
- the design loads;
- the protective function.

The vegetation engineering objectives relate to:

- the prevention of standing water;
- water supply either through water storage or ponding;
- increasing the depth of the layer available for root penetration;
- the type and form of the desired.

## 10.2 Requirements

Depending on the respective material group for drainage layers, the following properties must be taken into account:

- compatibility of materials (see section 7.10);
- environmental compatibility (see section 7.11);
- plant compatibility/phytotoxicity safety (see section 7.12);
- fire characteristics (see section 8.9);
- particle distribution (see section 10.2.1);
- weatherability (see section 10.2.2);
- structure and layer stability (see section 10.2.3);
- compression behavior (see section 10.2.4);
- water permeability (see section 10.2.5);
- water-storage capacity/maximum water capacity (see section 10.2.6);
- pH-value (see section 10.2.7);
- salt content (see section 10.2.9).

The requirements for bulk materials for drainage layers generally refer to the condition of defined laboratory compaction.

The different properties of the substances require a site and object-related assessment of their suitability.

The type and scope of standard suitability and control tests are specified in section 17. For examination methods see appendix B.

As a working aid for investigations, table 15 contains a summary of important requirements for the vegetation engineering properties of drainage materials.

### 10.2.1 Particle size distribution

In bulk materials, the proportion of constituents  $d < 0.063$  mm may not exceed 10% by mass.

Particle distribution depends on course depth and shall lie within these ranges:

- at course depth of 4 – 10 cm between 2/8 mm and 2/12 mm;
- at course depth of > 10 – 20 cm between 4/8 mm and 8/16 mm;
- at course depth of > 20 cm between 4/8 mm and 16/32 mm.

### **10.2.2 Weatherability**

The weather resistance of the materials is to be assured by the manufacturer. The requirements for the frost resistance of aggregates for concrete or building materials made of natural stone refer to static and/or dynamically highly stressed building materials and components. They can only be used to a limited extent for vegetation engineering assessment of materials for green roofs.

The manufacturer's specifications for drainage mats and drainage panels regarding their frost resistance must be noted.

### **10.2.3 Structure and layer stability**

The materials must have sufficient structural and dimensional stability as well as storage stability during construction and for the subsequent period. They must not be subject to any significant settling due to the dead weight of the structure, the influence of water or the maintenance and usage loads.

Drainage mats and panels made of plastics must be resistant to rotting caused by the substances and microorganisms occurring in the green roof structure for the given service life. Manufacturer's information must be observed.

The particle shape of aggregates plays a critical role in the stability of the material once it has been installed. In drainage courses with depths of between 4 and 10 cm, cracked particle aggregates should be stipulated, and for depths of over 10 cm also recommended.

### **10.2.4 Compression behavior**

The compression of plastic drainage mats and panels under load in the installed state must not impair their functionality (e.g. water permeability). For compression of substrate panels, see section 12.2.6

### **10.2.5 Water permeability**

The materials must have a high water permeability for the rapid removal of excess water into the roof drains.

The vertical water permeability for bulk materials, determined as water infiltration rate mod.  $K_f$  according to the method described in appendix B, attachment B.3, shall be mod.  $K_f \geq 0.3$  cm/s  $\triangleq$  180 mm/min. For drainage sub-areas of up to 400 m<sup>2</sup>, a functional fall of at least 2% and a maximum flow length of 15 m to the roof drain, drainage layers of 4 cm or more made from bulk materials are sufficiently functional. In the case of deviating areas, an individual proof must be provided.

In the case of green roofs with a thin layer structure, it must be taken into account that in rare rainfall events with high precipitation, the discharge of precipitation water can also occur partly over the surface and is not a defect, as long as there is no surface erosion.

The drainage performance of the drainage layer can be calculated as follows:

$$q' = \frac{A \times C_s \times q}{b} \quad \text{in } l/(s \times m)$$

where

- q' = volume discharge in l/(s x m) in the drainage course
- A = the surface area to be drained in m<sup>2</sup>
- C = the peak runoff coefficient/runoff reference value/coefficient of discharge (see 9.3.4)
- q = design rainfall in l/(s x m<sup>2</sup>)  
according to DIN EN 12056–3, DIN 1986–100 or local references
- b = calculated drain width in m

The efficiency of the materials used in the drainage course, as a function of the gradient and course depth, is to be proven by the manufacturer in the form of a runoff rate in l/(s x m).

These values are to be stated as a function of the pressure load. In the case of mineral bulk materials, particle size reduction resulting from mechanical, physical or chemical influences must be taken into account.

### 10.2.6 Water storage capacity/maximum water capacity

From a vegetation engineering point of view, bulk materials drainage layers made of open-pored and water-absorbent mineral substances are to be used if a higher water storage capacity is desired.

In the case of construction methods with ponding, bulk materials or dimensionally stable elements with a large-volume, water-absorbing hollow space must be used. Construction and materials must allow water level increases. In order to prevent waterlogging of the vegetation stratum and to ensure proper discharge of the excess water, a sufficient water-free void above the maximum water accumulation height must be present.

### 10.2.7 pH values

In the case of drainage layers from bulk materials, the pH value must be taken into account in connection with the requirements of the vegetation and the properties of the vegetation stratum. Thus, the drainage layer should have approximately the same pH as the vegetation stratum and should not deviate by more than 1.5 units from that of the vegetation stratum (see section 12.2.10).

The pH value for intensive and extensive green roofs should be between 6.0 and 8.5

Where the vegetation requires an acidic soil, e.g. heathers, the pH value should be specified.

### 10.2.8 Carbonate content

Carbonates are no longer among the evaluation criteria for drainage and vegetation support layers (see section 8.4).

The use of recycled concrete and chalk aggregates for drainage layers is not permitted (see section 8.4).

### 10.2.9 Salt content

In the interests of plant physiology, the soluble salt content in bulk materials and in drainage and substrate panels may not exceed:

- for intensive green roofs 2.5 g/l,
- for extensive green roofs 3.5 g/l

In the event that the soluble salt content in extracted water exceeds the prescribed limit, an additional test shall be carried out to determine the salt content in the extract with saturated gypsum solution, the result of which shall then be used to make an assessment and should not exceed:

- for intensive green roofs 1.5 g/l,
- for extensive green roofs 2.5 g/l

With regard to the potential risk of environmental pollution due to the leaching of salts, the aim should be to achieve the lowest possible salt levels.

## 10.3 Manufacture

The materials are to be installed evenly, taking into account the roof slope, the existing unevenness of the roof and the design-specific requirements for the surface layer. The tolerances shall not exceed the following minimum dimensions over a measured distance of 4 m:

- With a layer thickness less than 10 cm 1.0 cm;
- With a layer thickness of > 10 – 20 cm 1.5 cm
- With a layer thickness of > 20 cm 2.0 cm

The specified minimum layer thickness must be adhered to at all points. The installation of the following layers must not impair the functionality. When using drainage mats and panels, the evenness depends on the type and extent of the roof irregularities. With a roof fall of < 2 %, the unevenness must be compensated for by suitable measures, e.g. thicker drainage layer. Drainage mats and panels must be laid or installed in such a way that bulk materials cannot penetrate into underlying layers. In the case of bulk materials with sharp-edged and tapered particle shapes and with hard-faced drainage panels exerting edge pressure, higher mechanical stresses on roof waterproofing/root barrier membranes may occur, which require a corresponding protective layer/protective ply (see section 8.3).

---

## 11 Filter Layer

---

### 11.1 Material groups and types

For green roofs, geotextiles in the form of nonwovens or weaves are used as the filter layer. The filter layer is either installed in a separate operation on the drainage layer or it is part of pre-fabricated drainage mats.

Nonwovens consist of directional or randomly deposited fibers of any length. Fiber consolidation may be by mechanical or thermal methods or combinations thereof.

Nonwovens must be detector-tested in order to exclude the presence of broken needles in the fleece.

### 11.2 Requirements

In accordance with the FGSV-„Merkblatt über die Anwendung von Geokunststoffen im Erdbau des Straßenbaues“, the following characteristics must be considered:

- Environmental compatibility (see section 7.11);
- Plant compatibility/risk of phytotoxicity (see section 7.12);
- Fire characteristics (see section 8.9);
- Area density (see section 11.2.1);
- Mechanical stress resistance (see section 11.2.2);
- Effectiveness of mechanical filtration/mesh width (see section 11.2.3);
- Root penetrability (see section 11.2.4);
- Weatherability (see section 11.2.5);
- Resistance to microorganisms (see section 11.2.6);
- Resistance to chemical influences (see section 11.2.7);
- Tensile strength, elasticity, coefficient of friction (see section 11.2.8).

#### 11.2.1 Area density

The area density should be at least 100 g/m<sup>2</sup>. As a rule, it is between 100-200 g/m<sup>2</sup> for vegetation strata up to 25 cm thick. For thicker layers and for more steeply inclined roofs, higher area densities may be required due to the requirements of the press-through resistance or the tensile strength and extensibility, depending on the material and structure.

#### 11.2.2 Mechanical stress resistance

If no significant mechanical stresses are expected during construction, e.g. by being driven on by construction machinery or by subsequent follow-up loads, the (GRK) 1 for nonwoven fabrics usually with a punch pushing force  $\geq 0.5$  kN is sufficient.

### **11.2.3 Effectiveness of mechanical filtration/mesh width**

The mechanical filtration efficiency of a nonwoven fabric is characterized by the effective mesh width  $O_{90}$  according to the FGSV "Merkblatt über die Anwendung von Geokunststoffen im Erdbau des Straßenbaues". The effective opening width  $O_{90}$  indicates the diameter of the particle fraction of a uniform test soil 90% of which is retained by the geotextile and 10% is allowed to pass through.

For green roof purposes, the depth and composition of the vegetation strata (see table 3 and section 12.2.2) dictate that filter layers with an effective gap width of  $0.06 \text{ mm} \leq \text{weight } O_{90} < 0.2 \text{ mm}$  are adequate.

### **11.2.4 Root penetrability**

Geotextiles/webbing must be rootable. The rooting of the drainage layer must not be hindered, especially in extensive green areas, since this serves as a root space in a layer structure with a low overall thickness.

### **11.2.5 Weatherability**

In accordance with the FGSV - "Merkblatt über die Anwendung von Geokunststoffen im Erdbau des Straßenbaues", loosely laid geotextiles/webbing are not weatherproof. The manufacturer's specifications for maximum outdoor storage times are to be taken into account.

### **11.2.6 Resistance to microorganisms**

In accordance with the FGSV-"Merkblatt über die Anwendung von Geokunststoffen im Erdbau des Straßenbaues", the resistance to microbiological attacks according to DIN EN 12225 must be checked by incorporation in humus soil.

### **11.2.7 Resistance to chemical influences**

The product manufacturer shall provide proof of resistance to chemicals. As a rule, the durability of the product for the given period of use must be proven.

### **11.2.8 Coefficient of friction, elasticity and tensile strength,**

The requirement for these properties, where necessary, is object specific, e.g. steeply pitched roofs, and must be specified and proven for the intended construction.

### 11.3 Manufacture

Geotextiles/webbing for filter layers must be laid with at least 10 cm overlap of the rolls. They are to be run up the edges so as to avoid entry of substrate into the drainage layer and they are not to be exposed to the weather or to be seen.

During installation, covering with the vegetation substrate should be carried out immediately after laying the geotextiles/webbing. If this is not possible, the exposed period should be short and the maximum permissible exposure time specified by the manufacturer should not be used up as far as possible.

Exposed geotextiles/webbing must be secured against wind suction during periods of exposure.

Geotextile-laminated drainage mats, which are run up at roof edges or rising structural elements, are to be permanently protected from the weather.

If irrigation by ponding is intended, the water-free void in the drainage layer may not be reduced at any point by the construction. The filter layer may not touch the surface of the maximum water level.

---

## 12 Vegetation Stratum

---

The vegetation stratum forms the basis for plant growth and must be intensely rootable. This requires specific physical, chemical and biological properties. The vegetation layer must be structurally stable, store infiltrating water available to plants and only release surplus water. Even at maximum water capacity, it must have a sufficient volume of air for the respective vegetation form.

### 12.1 Material groups and types

Depending on the material composition and the production of the layer, as well as in connection with the greening and vegetation types, a distinction is made between the following material groups and types for growing media in the formation of the vegetation stratum:

- Bulk materials
  - improved top and subsoil;
  - mineral aggregates;
    - with and without organic material;
- substrate panels
  - made from modified foam materials;
  - made from mineral fibers;
- water storage layers
  - made from geotextiles;
  - made from matss;
  - made from panelss;
- Vegetation mats
  - with mineral/organic aggregate mixturess;
    - with permanent or decomposable supporting inserts;
    - with structural functionality.

The materials and dimensions chosen for this layer will be determined by local construction requirements and by objectives for the vegetation.

Construction requirements relate to:

- the drainage function;
- design load;
- the protective function;

Objectives for the vegetation relate to:

- the demands imposed by the desired greening type and the vegetation;
- permanently ensured functions;
- limiting the cost of development and maintenance care.

If substrates or soils are used for the vegetation stratum according to requirements other than those specified here, (e.g. for landscaping, earthworks, sports ground construction or tree planting - see section 1.1), then it may be necessary to incorporate a further layer with a graded particle size distribution, or other means to ensure that it does not lead water logging through capillary damage.

In order to avoid sagging, water logging or putrefaction in a vegetation stratum thicker than 35 cm, the proportion of organic material needs to be reduced. Alternatively, a distinction can be made between an upper and lower substrate, whereby the lower substrate contains little organic material and has a lower water capacity.

When using a single layer construction for intensive green roofs, it is necessary to consider the lower water and nutrient storage capacity of the substrate. Either plants that have lower water and nutrient requirements are to be used or extra maintenance procedures are to be planned to ensure that the needs of the vegetation are met.

When using the single-layered construction for turfed areas for games, sports and representative purposes, the greening should be done with imported turf. For multi-layered constructions, seeding is possible.

Where extremely thin layers are to be installed, vegetation matting can also act as the vegetation stratum. When laid on a substrate layer, they are to be considered as a method of greening (see 14.1).

Substrates for vegetation mats correspond to the group of mineral bulk materials with low organic matter content. They differ in their material composition and particle size distribution from the mixtures incorporated as a layer.

## 12.2 Requirements

Attention shall be paid to the following properties in respect to vegetation support courses, depending upon the type of greening which is being undertaken:

- Environmental compatibility (see section 7.11);
- Plant compatibility/risk of phytotoxicity (see section 7.12);
- Fire characteristics (see section 8.9);
- Particle distribution (see section 12.2.2);
- Organic matter content (see section 12.2.3);
- Weatherability (see section 12.2.4);
- Structural and layer stability of soils and bulk materials (see section 12.2.5);
- Compression behavior of substrate panels (see section 12.2.6);
- Water permeability (see section 12.2.7);
- Water storage ability/maximum water capacity (see section 12.2.8);
- Air content (see section 12.2.9);
- pH value (see section 12.2.10);
- Salt content (see section 12.2.11);
- Nutrient content (see section 12.2.12);
- Adsorptive capacity (see section 12.2.13);

- Seed germination/regenerative plant parts (see section 12.2.14);
- Proportion of foreign substances (see section 12.2.15).

The total pore volume is not a reference value, but it is used to determine the air content at maximum water capacity and at pF 1.8.

An approximation of the volume of water available to the plants may be obtained from the maximum water capacity minus a portion of around 10 - 15 % to account for the water held in the fine pores at pF > 4.2.

As a rule, requirements in respect to growing media relate to the compacted condition as a defined laboratory standard.

Details of the type and scope of suitability and inspection tests are set out in section 17. The testing methods are described in appendix B.

As a working aid for testing, tables 18-22 contain important requirements for the vegetation engineering properties of growing media, differentiated according to the types of greening and construction methods.

### **12.2.1 Classification of the substrates for the greening types**

By using single-layer construction methods also for intensive greening and the inclusion of a separate turf construction, the following classification for the requirements of substrates is made (see also table 5).

- Intensive greening
  - greening except turf;
    - single-layer construction;
    - multi-layer construction;
  - greening with turf;
    - single-layer constructionf;
    - multi-layer constructionf;
- Extensive greening
  - single-layer constructionf;
  - multi-layer construction.

### 12.2.2 Particle size distribution <sup>1)</sup>

When growing media are installed, the content of silts and clays ( $d \leq 0.063 \text{ mm}$ ) shall not exceed those given in table 5:

**Table 5: Limiting the content of silts and clays ( $d \leq 0.063 \text{ mm}$ ) for substrates of different planting types 1)**

No.	1				2	
1	Intensive greening				Extensive greening	
2	Greening except turf		Greening with turf			
3	single-layer	multi-layer	single-layer	multi-layer	single-layer	multi-layer
4	$\leq 10$	$\leq 20$	$\leq 10$	$\leq 20$	$\leq 10$	$\leq 15$
	given in % by mass				given in % by mass	

<sup>1)</sup> The substrate requirements for intensive greening or extensive greening in single-layer construction are identical with the exception of greening with turf.

The largest particle to be used for greening on flat roofs depends on the thickness of the vegetation stratum and must not exceed, for

- up to 10 cm  $d = 12.5 \text{ mm}$ ,
- over 10 cm  $d = 16 \text{ mm}$
- and for greening with turf, regardless of the thickness  $d = 8 \text{ mm}$

The particle size distribution ranges shown in the following list serve as an aid for the selection of a suitable particle size distribution

**Table 6: Overview of particle size distribution ranges 1)**

No.	1				2	
1	Intensive greening				Extensive greening	
2	Greening except turf		Greening with turf			
3	single-layer	multi-layer	single-layer	multi-layer	single-layer	multi-layer
4	s. Fig. 3	s. Fig. 4	s. Fig. 5	s. Fig. 6	s. Fig. 7	s. Fig. 8

<sup>1)</sup> The corresponding coordinates are given in tables 7 - 9.

**Table 7: Coordinates of the particle size distribution range for intensive substrates (except greening with turf)**

No.	1	2			
1	Particle size in mm	Coordinates of the range limits for intensive substrates (except greening with turf)			
		Single-layer construction		Multi-layer construction	
		left range limit	right range limit	left range limit	right range limit
2	0.06	10	-	20	0
	0.2	15	-	36	10
	0.6	25	-	70	21
	1.0	33	-	100	28
	2.0	50	0	-	40
	4.0	80	25	-	58
	6.3	100	43	-	72
	10.0	-	69	-	92
	12.5	-	80	-	100
	16.0	-	100	-	-

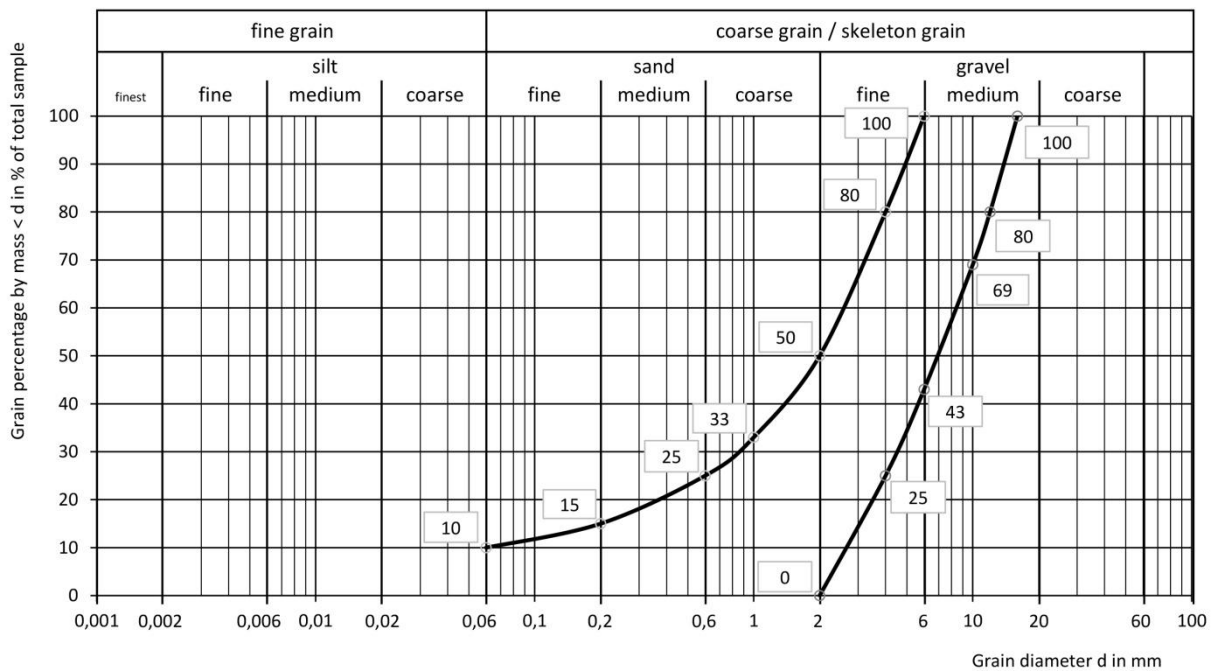

**Figure 3: Particle size distribution range for single-layer intensive substrates (except greening with turf)**

**Note:** The illustrated particle size distribution range is an orientation aid. Only the functional requirements of this guideline are decisive for the assessment.

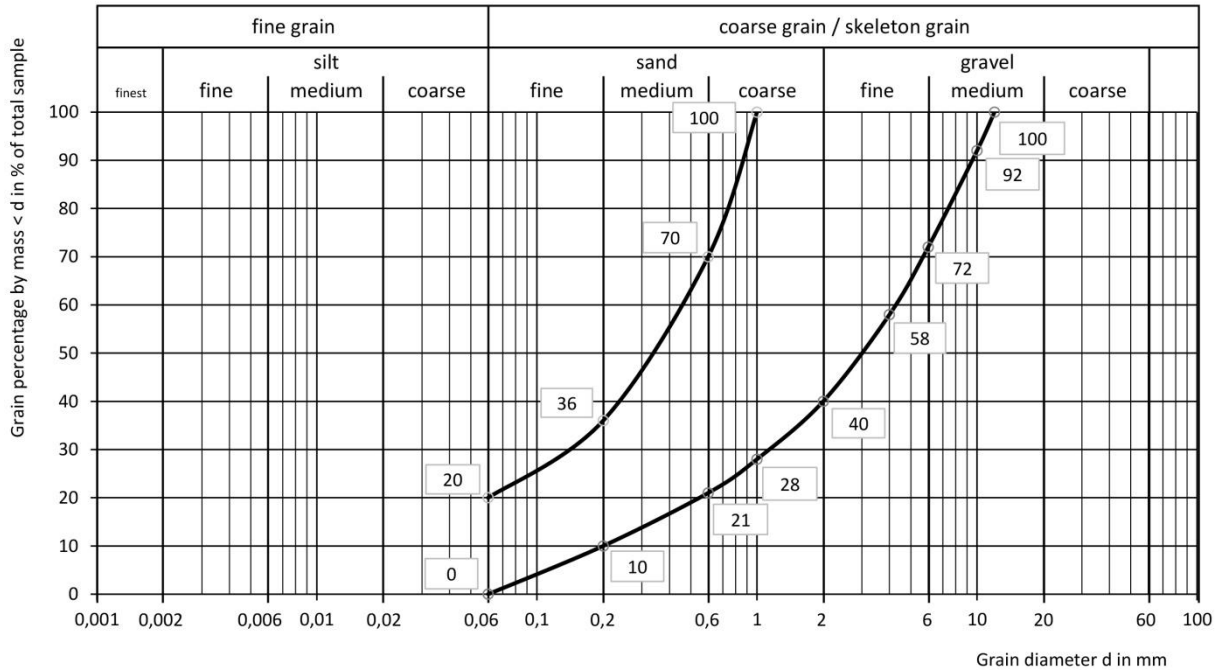
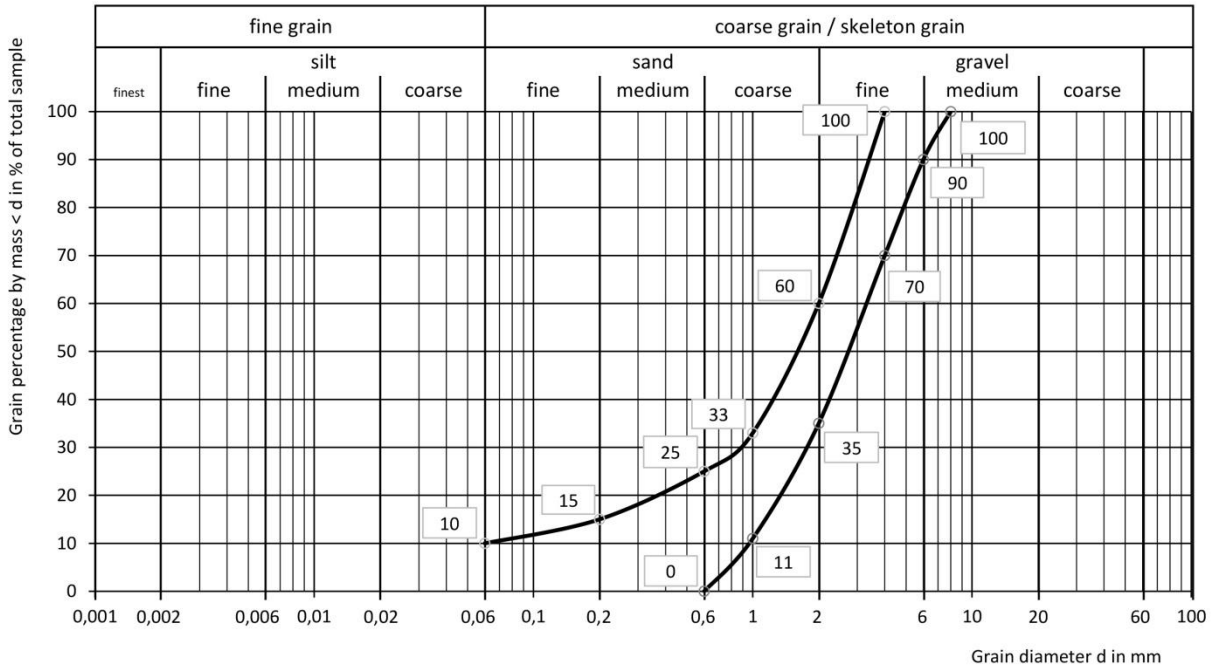

**Figure 4: Particle size distribution range for multi-layer intensive substrates (except green- ing with turf)**

**Note:** The illustrated particle size distribution range is an orientation aid. Only the functional re- quirements of this guideline are decisive for the assessment.

**Table 8: Coordinates of the particle size distribution range for turf substrates**

No.	1	2			
1	Particle size in mm	Coordinates of the range limits for turf substrates			
		Single-layer construction		Multi-layer construction	
		left range limit	right range limit	left range limit	right range limit
2	0.06	10	-	20	0
	0.2	15	-	45	15
	0.6	25	0	80	35
	1.0	33	11	100	47
	2.0	60	35	-	62
	4.0	100	70	-	82
	6.3	-	90	-	95
	8.0	-	100	-	100
	10.0	-	-	-	-
	12.5	-	-	-	-
	16.0	-	-	-	-



**Figure 5: Particle size distribution range for single-layer turf substrates**

**Note:** The illustrated particle size distribution range is an orientation aid. Only the functional requirements of this guideline are decisive for the assessment.

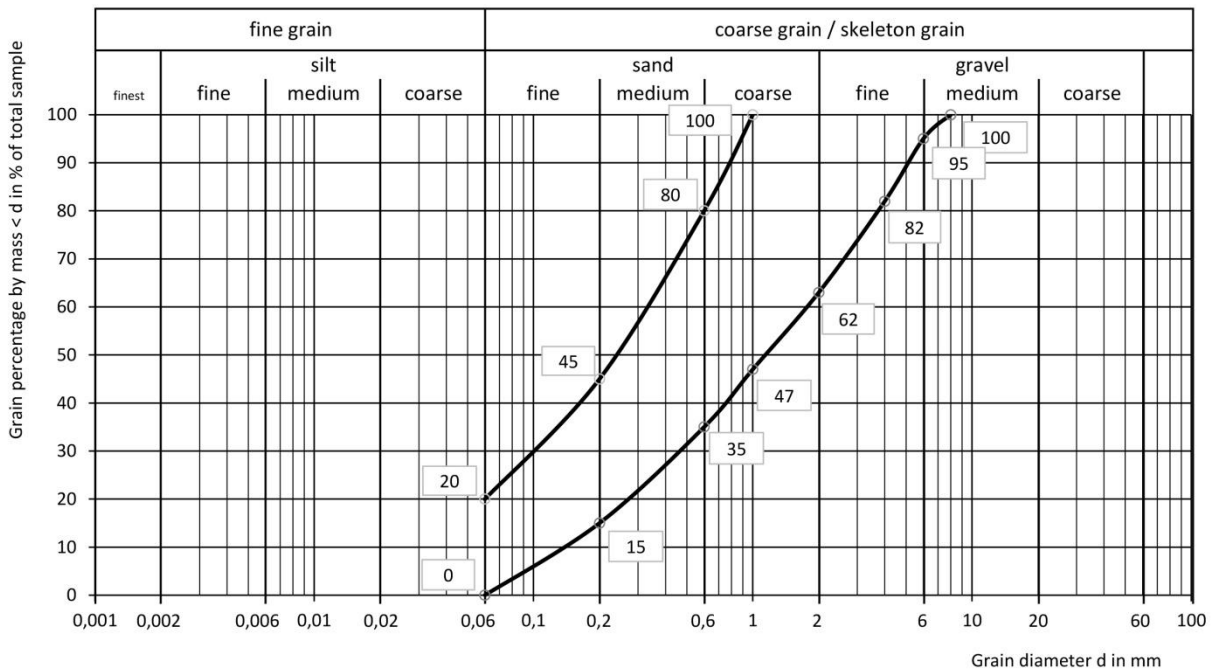
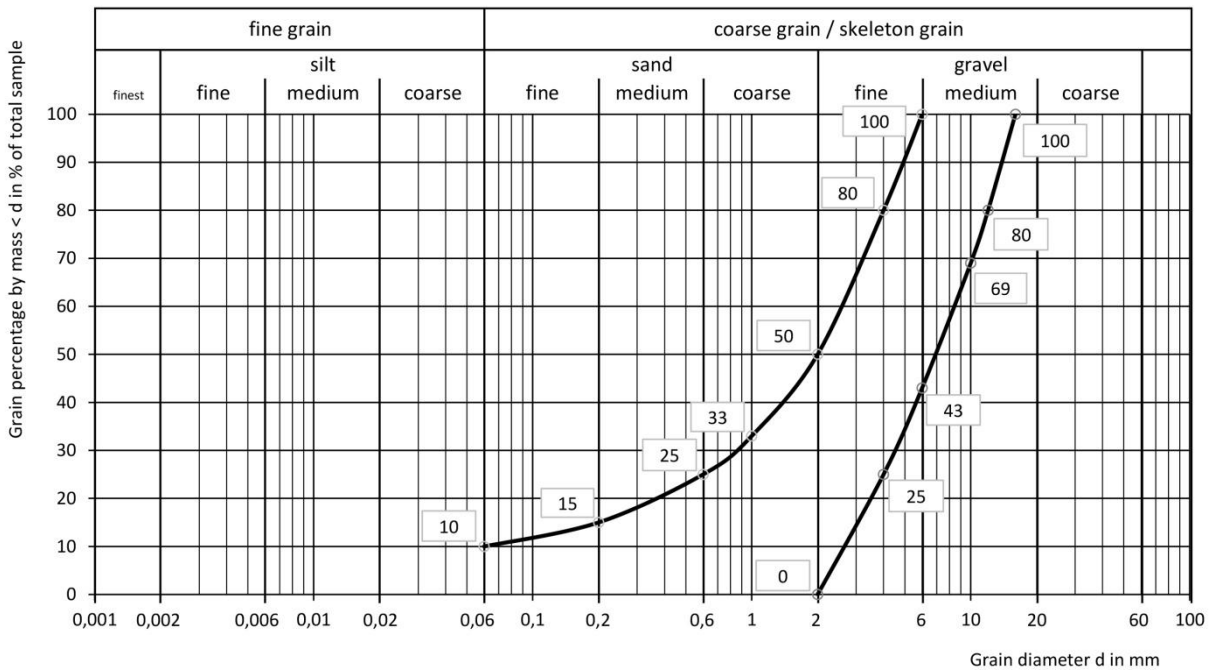

**Figure 6: Particle size distribution range for multi-layer turf substrates**

**Note:** The illustrated particle size distribution range is an orientation aid. Only the functional requirements of this guideline are decisive for the assessment.

**Table 9: Coordinates of the particle size distribution range for extensive substrates**

No.	1	2			
1	Particle size in mm	Coordinates of the range limits for extensive substrates			
		Single-layer construction			
		left range limit			left range limit
2	0.06	10	-	15	-
	0.2	15	-	30	-
	0.6	25	-	50	0
	1.0	33	-	62	11
	2.0	50	0	80	30
	4.0	80	25	100	50
	6.3	100	43	-	63
	10.0	-	69	-	81
	12.5	-	80	-	88
	16.0	-	100	-	100



**Figure 7: Particle size distribution range for single-layer extensive substrates**

**Note:** The illustrated particle size distribution range is an orientation aid. Only the functional requirements of this guideline are decisive for the assessment.

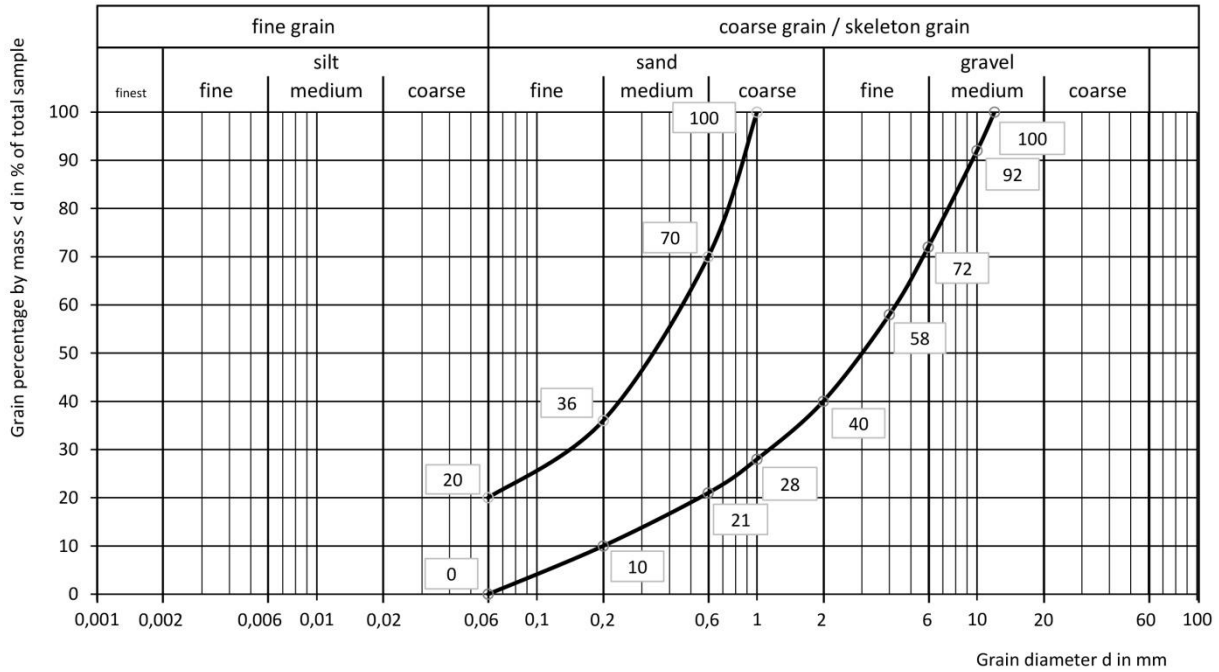

**Figure 8: Particle size distribution range for multi-layer extensive substrates**

**Note:** The illustrated particle size distribution range is an orientation aid. Only the functional requirements of this guideline are decisive for the assessment.

### 12.2.3 Organic matter content

The content of organic matter in growing media should be as follows:

**Table 10: Organic matter content**

No.	1				2	
1	Intensive greening				Extensive greening	
2	Greening except turf		Greening with turf			
3	single-layer	multi-layer	single-layer	multi-layer	single-layer	multi-layer
4	≤ 40 g/l	≤ 90 g/l	≤ 40 g/l	≤ 65 g/l	≤ 40 g/l	≤ 65 g/l

Special vegetation forms, e.g. moor plants, may require a higher proportion of organic matter.

### 12.2.4 Weatherability

The weather resistance of the mineral scaffolding materials is to be assured by the manufacturer. The requirements for the frost resistance of aggregates for concrete or building materials made of natural stone refer to statically and/or dynamically highly stressed building materials and components. They can only be used to a limited extent for a vegetation engineering assessment of substances for vegetation strata.

### 12.2.5 Structural and layer stability of soils and bulk materials

Growing media from soils and bulk materials must have sufficient structural and storage stability. The particle size distribution and the particle shape essentially determine this. It is therefore necessary to use broken particles as scaffold-forming substances. This is especially true for extensive greening.

The extent of subsidence due to the dead load of the structure, influence of water, implementation processes or maintenance loads, within the period of limitation for claims for defects, may not be more than

- 10% of the nominal thickness for layer thicknesses up to 50 cm,
- on average more than 5 cm for layer thicknesses of more than 50 cm

### 12.2.6 Compression behavior of substrate panels

The long-term compression of substrate panels under load in the installed state may not be more than

- 20% of the nominal thickness at 30 - 50 mm panel thickness,
- 10 mm for panels > 50 mm thick.

### 12.2.7 Water permeability

The water permeability of growing media has to be adapted to the intended drainage layer construction. It is determined as a water infiltration rate mod.  $K_f$  and should be for substrates in the compressed state or for substrate/water storage panels in the installed state as follows:

**Table 11: Water permeability of growing media**

No.	1				2	
1	Intensive greening				Extensive greening	
2	Greening except turf		Greening with turf		Greening except turf	
3	single-layer	multi-layer	single-layer	multi-layer	single-layer	multi-layer
4	60 – 400 mm/min	0.3 – 30 mm/min	60 – 200 mm/min	0.6 – 70 mm/min	60 – 400 mm/min	0.6 – 70 mm/min

Due to the different references values/units in the test reports, table 12 compares the minimum values of water permeability. The value  $l/m^2/h$  is only an illustration of the order of magnitude and may not be used for further calculations.

**Table 12: Conversion table for the water permeability of the vegetation stratum**

No.	1	2				3	
1	Unit	Intensive greening				Extensive greening	
		Greening except turf		Greening with turf			
		single-layer	multi-layer	single-layer	multi-layer	single-layer	multi-layer
2	mm/min	60	0.3	60	0.6	60	0.6
3	cm/s	0.1	0.0005	0.1	0.001	0.1	0.001
4	m/s	0.001	0.000005	0.001	0.00001	0.001	0.00001
5	m/s	1.00E-03	5.00E-06	1.00E-03	1.00E-05	1.00E-03	1.00E-05
6	~ l/m <sup>2</sup> /h	3600	18	3600	36	3600	36

### 12.2.8 Water storage ability/maximum water capacity

The maximum water capacity of growing media, as a parameter for the water storage capacity, should have the following values in the compressed or installed state and, in order to avoid waterlogging, not exceed the value of 65 % vol. (see table 13):

**Table 13: Water capacity of growing media**

No.	1				2	
1	Intensive greening				Extensive greening	
2	Greening except turf		Greening with turf		Greening except turf	
3	single-layer	multi-layer	single-layer	multi-layer	single-layer	multi-layer
4	≥ 30 % vol. ≤ 65 % vol.	≥ 45 % vol. ≤ 65 % vol.	≥ 30 % vol. ≤ 65 % vol.	≥ 35 % vol. ≤ 65 % vol.	≥ 20 % vol. ≤ 65 % vol.	≥ 35 % vol. ≤ 65 % vol.

### 12.2.9 Air content

When growing media are at full water capacity, the amount of air present shall be no less than 10 % vol.

If the determined value is lower, then the air content at pF 1.8 shall be used to make an assessment. At pF 1.8 (proportion of large pores), it should be ≥ 20 % vol.

### 12.2.10 pH value

In the vegetation stratum, the pH value must be considered in connection with the requirements of the vegetation. It should be between 6.0 and 8.5 and for turf substrates between 5.5 and 7.5.

Taking into account the requirements of the vegetation, a decrease in the pH of the substrate below the allowable range after installation, e.g. by adding dolomite or travertine gravel is to be prevented.

For vegetation that prefer acidic soil conditions, e.g. moor/peat plants, the required lower pH value is to be specified.

### 12.2.11 Salt content

In growing media, the content of soluble salts shall not exceed the figures shown below:

- for intensive greening 2.5 g/l,
- for extensive greening 3.5 g/l.

If, in the determination in the water extract, the limit value is exceeded, an additional test shall be carried out using a saturated gypsum solution to make an assessment. The values should not exceed:

- for intensive greening 1.5 g/l,
- for extensive greening 2.5 g/l.

With regard to the potential risk of environmental pollution due to the leaching of salts, the aim should be to achieve the lowest possible salt levels.

Where plants are to be used which are sensitive to salt, such as moor/peat plants, the salt content shall not exceed 1.0 g/l.

### 12.2.12 Nutrient content

The nutrient content in growing media should be kept as low as possible and should not exceed the values shown in table 6. Stocking high levels of nutrients in the period between installation and greening is to be avoided because of possible environmental pollution by leaching. Supplementary nutrient supply by fertilizing, which may be required, should only be carried out after the greening or during services for completion (completion care) with suitable fertilizers (see section 14.5). In the context of maintenance services for the development and maintenance of vegetation (development and maintenance care), further nutrient inputs may be required if necessary.

It should be noted, that according to Düngegesetz (DüNG) [Fertilizer Act] and Düngemittelverordnung (DüMV) [Fertilizer Ordinance] growing media have to be declared (see section 7.11).

**Table 14: Nutrient contents in growing media for intensive and extensive greening, investigation methods (determination according to VDLUFA)**

No.	1	2		3		4		5	
1	Nutrient	N		P <sub>2</sub> O <sub>5</sub>		K <sub>2</sub> O		Mg	
2	Investigation method	CaCl <sub>2</sub>	CAT	CAL	CAT	CAL	CAT	CaCl <sub>2</sub>	CAT
3	Nutrient in mg/l	≤ 80	≤ 80	≤ 200	≤ 50	≤ 700	≤ 500	≤ 200	≤ 200

### **12.2.13 Adsorptive capacity**

No value is given for the adsorption capacity of growing media. It can be declared by specifying the analysis method.

### **12.2.14 Content of viable seed regenerative plant parts**

The materials used for the vegetation substrate should contain no living plants, nor any regenerative plant parts, particularly weed roots. Where soils are used in growing media, subsoil rather than topsoil should be used to avoid the risk of importing seeds which are capable of germinating.

During the extraction and preparation of the raw materials and the manufacture and storage of growing media, care needs to be taken at all times to avoid the inclusion of seeds.

### **12.2.15 Foreign substances**

The proportion of identifiable foreign substances over 6 mm in diameter (the smallest diameter is measured), e.g. wall and floor tiles, glass, ceramics shall not exceed 0.3 % mass. The proportion of metals or plastics shall not exceed 0.1 % mass. For plastics, a total area per liter substrate of 10 cm<sup>2</sup> may not be exceeded.

## **12.3 Manufacture**

Unless soil modelling is planned, the vegetation stratum will generally be installed parallel to the underlying layers. The prescribed minimum depth must be respected throughout.

Vegetation stratum made from soils and bulk materials must be installed in a naturally moist condition.

The material-specific depths required after laying, shall be achieved by applying pressure. Allowance needs to be made for settling when deciding on the installation levels. The ATV DIN 18320 must be respected. This stipulates that the vegetation stratum thickness has to be determined in a settled condition at the time and location of the acceptance of the work.

Substrate panels and water storage layers shall be protected against soaking and are to be laid in a dry condition as per delivery.

If necessary, a permanent watering arrangement may be used to keep the vegetation stratum damp and thereby stopping the surface from drying out and preventing wind erosion. If there is a lengthy interval between installation and greening, additional preventive measures may be needed to prevent erosion (see 8.10.1.1). Areas planted with shrubs and bushes may be mulched with suitable materials to protect them after planting. The use of mulch may not interfere with the functionality of the vegetation stratum with regard to water and air content.

All values defined for particle size distribution (see section 12.2.2) apply to substrates in an installed condition. If substrates are blown onto the roof by means of a silo vehicle, changes in the particle size distribution may occur depending on the source material. To a limited extent, this effect can be counteracted by adding higher proportions of larger particles to the substrate during the manufacturing process.

---

## 13 Requirements for Seeds, Plants and Vegetation

---

### 13.1 Breeding and trading groups

A distinction is made between the following breeding and trading groups:

- Seeds;
- Shoots;
- Perennials;
- Bulbs;
- Woody plants;
- Turfs;
- Vegetation mats.

### 13.2 Requirements

#### 13.2.1 Seeds

Grass seed must comply with DIN 18917 and thus with the FLL-„Regel-Saatgut-Mischungen Rasen - RSM Rasen“.

Herb seed must comply with DIN 18917 or the FLL-„Regel-Saatgut-Mischungen Rasen - RSM Rasen“.

For the production of turf in intensive greening for games, sports and representation purposes, the suitable regular seed mixture, e.g. 2.2 Grass in dry area, 2.3 Grass for games or 5.1 Grass for car parks, according to the applicable RSM turf use must be used. For simple intensive greening, different compositions of the seed mixtures may be required.

For extensive vegetation with grass and herb vegetation, the regular seed mixture RSM Grass 6.1 Extensive green roofs or RSM Grass 7.2 Landscape grass-dry areas can be used. For other types of vegetation, site and object-related compositions of the seed mixtures are to be specified.

For green roofs according to nature conservation requirements (see section 4.4) or as a contribution to biodiversity (see section 9.5), the FLL-„Empfehlungen für Begrünungen mit gebietseigenem Saatgut“ can be used.

The „Hinweise für die Ausschreibung von Saatgut nach RSM Rasen oder nach Begrünungen mit gebietseigenem Saatgut“ (Beiblatt zur FLL-„Regel-Saatgut-Mischungen Rasen - RSM Rasen“) are to be considered.

#### 13.2.2 Shoots

Shoots from plants of the genus *Sedum* are subject to the requirements of the FLL-„Gütebestimmungen für Stauden“.

### **13.2.3 Perennials**

Perennials are subject to DIN 18916 and must therefore comply with the FLL-„Gütebestimmungen für Stauden“.

Green roofs require that care be taken to ensure that the root ball height fits to the thickness of the vegetation stratum. Perennials grown in heavy soils or humus substrates are not suitable for use on green roofs due to the risk of frost lift.

Plants must show strong growth, have only been fertilized with moderate amounts of nitrogen, and must be hardened off adequately. They must not be taken directly from a culture under glass.

Before wild perennial species are used, evidence must be provided to show that they have been nursery-grown and not removed from the wild.

### **13.2.4 Bulbs**

The usual trade classifications apply to bulbs. It may be necessary to provide evidence to show that they have been nursery-grown and not removed from the wild.

Where bulbs with vegetative growth are used for extensive greening, small or flat rootballs are preferable. The plants should be grown in primarily mineral substrates.

### **13.2.5 Woody plants**

Woody plants must comply with DIN 18916 and thus with the FLL-„Gütebestimmungen für Baumschulpflanzen“.

It is also recommended that only non-grafted shrubs be used for green roofing. Where the vegetation stratum is relatively shallow, plants with flat rootballs must be specified. The substrates in which the pot, container and flat-rootball plants are grown should comprise mainly of mineral substances. The exception is for substrates used for special humus rooting plants. Solitary plants grown on heavy soils are generally not suitable for use on green roofs.

Root balls must be free of any foreign vegetation, particularly those species which form rhizomes and runners.

Young plants should be used for extensive greening.

For green roofs, it is recommended that nursery contracts be agreed, specifying substrate types, rootball heights and cultivation arrangements.

### **13.2.6 Turf**

Turf is subject to the requirements in DIN 18917 and the FLL-„TL Fertigrasen – Technische Lieferbedingungen für Rasensoden aus Anzuchtbeständen“.

Turf grass for green roofs must be grown on a sandy soil containing light to moderate amounts of humus.

Landscape turf can be used in simple intensive greening on drought-prone locations and in extensive green areas with sufficient layer thickness and suitability according to FLL-„Regel-Saatgut-Mischungen Rasen - RSM Rasen“. Additional herbaceous plant seed to RSM standards may be added, provided this includes no leguminous species. No clover species may be present in turf.

### **13.2.7 Vegetation mats**

Vegetation matting is to be made with suitable supporting inserts for the purposes of cultivation, transport, laying and use. At locations where the vegetation mats are subjected to tensile stress, the requirements for the supporting inserts should be specified. Geotextile underlays must fulfill their function up to the point of substantial rooting of the vegetation layer (lifting test). See section 12.1 regarding the substrates used to fill vegetation mats.

Vegetation matting must be of a uniform thickness and must allow cavity-free laying.

The vegetation must be sufficiently hardened during culture. The vegetation mats must not come directly from a culture under glass. Hardened plants can be recognized by a species-appropriate formation of shoots and short internodes.

The desired vegetation form (see section 5.2.4) should be specified with an appropriate distribution on mosses, succulents, grasses, herbs and bulbous plants.

The total coverage should be at least 75% before use in projective determination. In this case, foreign stock with a coverage of not more than 20% is permitted.

The loss of filling substrate by extraction, transport and installation, may not exceed 3% of the total area. A partial area without filler substrate may not be larger than 30 cm<sup>2</sup>. Each m<sup>2</sup> of vegetation mat may not have more than 10 partial areas of this size. A larger number of smaller subareas is permissible, but in total must not exceed the coverage ratio of 3%.

---

## 14 Planting and Seeding

---

### 14.1 Greening procedure

Greening procedures must be appropriate to the biological characteristics of:

- individual plant species;
- the different forms of vegetation;
- the qualitative greening objective.

These procedures can be modified and combined to some extent.

The following options are available for establishing vegetation:

- dry seeding
  - without the use of adhesives for fixing;
  - using adhesives for fixing;
- wet seeding
  - without shoots;
  - in combination with spreading shoots;
- scattering plant parts
  - shoots;
  - rosettes;
- covering with pre-cultivated vegetation matting with
  - biodegradable support linings;
  - durable support linings;
  - durable structural linings;
- laying turf
  - without reinforcement;
  - with reinforcement;
- planting
  - individual plants;
  - pre-cultivated plant elements.

## 14.2 Implementation

Depending on the type of greening procedure, DIN 18916, DIN 18917 or DIN 18918 must be observed.

The following regular amounts are recommended for:

- dry seeding 3000 – 5000 grains/m<sup>2</sup>;
- wet seeding
  - without shoots 3000 – 5000 grains/m<sup>2</sup>;
  - with shoots 1500 – 3000 grains/m<sup>2</sup> as well as 30 g/m<sup>2</sup>, with min. 50 shoots of at least 4 species;
- scattering shoots 60 g/m<sup>2</sup> with min. 100 shoots of at least 4 species;
- planting min. 16 plants/m<sup>2</sup> for a pot volume of 50 cm<sup>3</sup>.  
For smaller pots the number has to be increased accordingly.

## 14.3 Securing the stability of woody plants

### 14.3.1 Requirements

The stability of larger trees and shrubs can be achieved through

- bracing and;
- anchoring.

Measures for securing by bracing and anchoring serve the temporary stability assurance of the trees and shrubs. It is assumed that the specified minimum layer thicknesses are not undercut and a sufficiently rootable substrate volume is present.

During the working life of anchors and bracing, the trees and shrubs must be regularly checked for constrictions, pressure and chafing damage.

### 14.3.2 Tension

Wire and rope bracing should be provided with a tightening mechanism. They can be attached:

- with threaded anchors directly on the structure above the waterproofing. The connection is to be in a screwable form;
- to building elements with appropriate structural and static properties, e.g. edging, walls, large-sized floor panels;
- to building elements embedded in the green roof structure, e.g. ground panels, mesh mats. The permissible load-bearing capacity of the elements and/or the thermal insulation and roof waterproofing must not be exceeded. The bracing to the elements should not exceed an angle of 60°.

### **14.3.3 Anchoring to support frames**

Square or triangular frames are suitable for anchoring trees. They are to be made of tubular steel with corrosion-resistant surface protection. The individual supports must be provided with load-distributing support plates.

### **14.4 Erosion protection**

Green roofs are susceptible to erosion up to full vegetation cover. For measures, see section 8.10.

### **14.5 Completion**

In order to achieve successful growth, services for completion (completion care) are defined in DIN 18916 and DIN 18917 and can be transferred to the described requirements and services on intensive green roofs. For extensive green areas and partially also for simple intensive green areas, a differentiation of the services and requirements is necessary. Depending on weather conditions and vegetation development, maintenance measures must be specified and carried out on an object-related basis. These can be:

- irrigation;
- starter fertilizing;
- subsequent fertilizing;
- removal of unwanted foreign vegetation;
- cutting back ground cover;
- rolling, following frost-induced ground lift;
- reworking vegetation matting joints;
- pruning woody plants;
- repeat seeding;
- repeat planting;
- pest control;
- keeping technical installations vegetation-free;
- keeping edging/safety margins and surface coverings free from dead leaves and overgrowing vegetation that might impair function.

In the terms of the contract,

- the maintenance objectives
- individual tasks for separate remuneration, specifying the type, extent, total duration of the task and the season;
- the successful desired, vegetative growth.

are to be described in detail.

Additional fertilizing should be carried out according to the nutrients in the substrate and the greening objectives. During starter and subsequent fertilizing, it is recommended that nutrients be administered by means of coated NPK slow-release fertilizer capsules, at the rates shown below

- Intensive greening sites 8 g N/m<sup>2</sup> (pure nitrogen), turf greening as necessary;
- Extensive greening sites 5 g N/m<sup>2</sup> (pure nitrogen).

Deep cutting and removal of the clippings can limit excessive levels of existing and/or repressive foreign vegetation. Herbicide application is not permitted.

## 14.6 Successful vegetative growth

The successful vegetative growth for intensive green roofs is defined in DIN 18916 and DIN 18917

For extensive green roofs, the following criteria for successful vegetative growth apply in addition to, or in deviation from, DIN 18916 and DIN 18917:

- Green roof vegetation produced by sowing and spreading sedum shoots should be as uniform as possible, which must have at least 60% projective soil cover when uncut. Sedum sprouts must present at least 75% of the agreed species and be established. The seed stock should consist of at least 60% of the seed mixture species. The species-appropriate seasonal state of the plants must be taken into account when determining the degree of coverage. Nursery and other foreign vegetation do not count towards the required cover ratio. If they make up more than 20% of the total coverage, the successful vegetative growth has not been achieved.
- Vegetation mats must be rooted firmly and not be liftable. The required species stock and its pro rata coverage must be present. The total coverage must be at least 80%. The species-appropriate seasonal state of the plants must be taken into account when determining the degree of coverage. The proportion of visible joints may not exceed 10% of the total amount.
- When assessing plantings of plants from pots or trays, failures of up to 5% of the total amount are not taken into account if a closed impression is created despite the failure of individual plants. The plants must show a species-appropriate growth and be rooted in the substrate of the vegetation stratum.
- If the tendering of the green roof prescribes plants from pot trays and if the state of acceptance is determined by the degree of coverage, this is to be agreed for the specific object and should also amount to 60%.
- Reference is made to the dependence on coverage, duration of completion services (completion care) and number of mini-rootball plants planted per square meter.
- A wilting and thus softened vegetation through excessive fertilization and watering is not acceptable.

---

## **15 Maintenance services for the development and maintenance of vegetation (development and maintenance care), maintenance**

---

### **15.1 General**

The maintenance services for the development and maintenance of vegetation (development and maintenance care) are defined in DIN 18919, described with individual measures for ground-based greening and transferred to intensive greening accordingly.

For extensive green areas and partially also for simple intensive green areas, maintenance objectives and individual measures are coordinated with the greening method, the vegetation form, the biodiversity or the created habitat as well as the state of development and the direction of development for the object. The necessary waterproofing inspections remain unaffected.

The range of greening objectives lies between aesthetic-ornamental gardens on one side and ecologically optimized green roofs on the other. Through the ongoing natural development, these pictures lose their clarity over the years. This can also be a desired effect. Otherwise, it will be necessary to intervene with suitable maintenance measures. The following describes all possible measures that come into question. The choice, type and extent are to be specified by a professional and are object-specific.

Maintenance contracts, with the definition of a long-term conception under specialist supervision by the planning and monitoring landscape architects and/or implementing contractors that extend beyond the defects limitation period are strongly recommended for both intensive and extensive green roofs.

In the contractual terms and conditions, the individual tasks should be clearly defined. These may be described by the type, extent, timing, and duration according to area (m<sup>2</sup>) (e.g. Vegetation area, edging/safety margin, surface covering), number or length (e.g. irrigation and drainage facilities). They may also be agreed upon as required.

During all works on roofs above a height of 3 m, protection against falling is required and the corresponding regulations governing the accident prevention have to be respected (see 7.7).

Where façade cleaning is required, the vegetation and layer structure will need to be protected against harmful substances before work starts.

### **15.2 Intensive greening**

For areas of intensive and simple intensive greening, it may be necessary to carry out the following tasks:

- Loosening and cleaning planted areas;
- Removal of unwanted vegetation, especially germinating woody plants;
- Removal of refuse;
- Fertilizing;
- Watering;
- Plant protection;

- Pruning;
- Mulching;
- Removing fallen leaves;
- Protective measures against frost and snow;
- Adjustment of anchors and bracing;
- Removal of unnecessary anchoring/bracing;
- Inspection and functional testing of irrigation systems;
- Inspection of the drainage system;
- Keeping edging and safety margins and paving free from dead leaves and overgrowing vegetation.

As a rule, 4 to 8 maintenance visits per year may be required.

In the case of turfs and grass-herb greening (meadow-like areas), the following services may be required in particular:

- Mowing;
- Removal of grass clippings;
- Removal of refuse;
- Fertilizing;
- Watering;
- Plant protection;
- Removal of leaves
- Repeat seeding;
- Inspection and functional testing of irrigation systems;
- Inspection of the drainage system;
- Keeping edging and safety margins and paving free from dead leaves and overgrowing vegetation.

As a rule, 2 to 4 maintenance visits per year may be required for grass-herb greening (meadow-like areas)

Turfed areas for games, sports and representation purposes are to be maintained intensively. Above all, the supply of water and nutrients must be carried out regularly in order to maintain the greening permanently. Too little care can be expressed in a lack of growth or stock conversion.

In addition, turfs may require:

- Scarifying;
- Aerating;
- Sanding.

Weekly maintenance during the growing season is the rule for turfed areas for games, sports and recreational purposes.

### 15.3 Extensive greening

The natural development dynamics of the vegetation on extensive green roofs begins after completion services (completion care). This can be influenced to a minimal extent through maintenance interventions, e.g. pruning measures or removal of individual plants. Migrating, high-growing, repressive plant species, e.g. some legumes (Fabaceae) should be removed at an early stage.

The maintenance services for the development of vegetation (development care) for extensive green roofs are carried out after the completion services (completion care) for a limited period, until a projective soil coverage of about 90% is achieved. This can extend over two years, depending on the greening procedure and the state of development. In particular, with growing media for single-layer constructions and more steeply sloping roofs, the nutrient supply must be ensured for this period.

As a rule, one to two inspections per year suffice to determine which maintenance services are necessary for the maintenance of vegetation (maintenance care).

2-4 visits may be necessary per a year.

The following services may be required in particular for extensive greening:

- Supply of nutrients;
- Irrigation of steeply sloping, sun-exposed roofs;
- Removal of woody seedlings and other unwanted growth;
- Pruning for thinning;
- Seeding in the case of larger barren areas with seeds or shoots of sedum species;
- Replanting for larger areas without sufficient coverage;
- Refilling of substrate in cases of erosion;
- Plant protection;
- Keeping the technical equipment free of vegetation;
- Keeping edging and safety margins and paving free from dead leaves and overgrowing vegetation.

Gravel edges and safety strips as well as paving and slab joints can self-fertilize. Low growing plants, e.g. moss, sedum and cushion-growing herbs and perennials should be tolerated. Unwanted spontaneous growth, especially in the case of vegetation-free fire protection strips, must be eliminated by regular maintenance, which must be agreed in terms of type, extent and frequency.

In extensive greening, the supply of nutrients can usually be limited to the temporary period of maintenance services for development. It is recommended to apply a NPK long-term fertilizer on a basis of 5 g N/m<sup>2</sup> and year.

In a nutrient-poor structure, e.g. single-layer and thin-layer constructions, it may be further necessary to undertake a maintenance fertilization at intervals of several years to maintain the desired vegetation and flowering aspect.

## 15.4 Maintenance

In connection with the operations of maintenance services for the development and maintenance of vegetation (development and maintenance care), the technical facilities are to be maintained. In particular:

- the functioning of the roof drains and the technical equipment for drainage and/or irrigation housed in inspection shafts;
- the removal of dirt and deposits in inspection shafts, on pop-up sprinklers and in roof drains, as well as drainage channels;
- the stability of balustrades, surface fastenings and other structural elements;
- the continued functionality of anti-slip devices on pitched roofs.

must be ensured.

Functionally impairing deposits in gravel strips, at entrances and closures as well as in gravel beds at technical facilities are to be removed at intervals of several years.

---

## 16 Acceptance, Claims for Defects

---

### 16.1 Acceptance

The acceptance of green roofs usually takes place when successful vegetative growth has been achieved.

The sown or planted vegetation should have had a rest period before acceptance and, if weather permitting, a dry or frost phase. An acceptable condition is usually achieved within 12 to 15 months.

In addition to or deviating from ATV DIN 18320, when sowing or spreading shoots, gaps smaller than 2.5 m<sup>2</sup> are not deducted.

The rule of oversight, according to which gaps below 100 m<sup>2</sup> are not deducted, does not apply to sowing on roof and decks.

As self-contained parts of the service, which are to be accepted separately on request in accordance with § 12 no. 2 VOB / B, the following apply:

- the completion of the roof waterproofing, as long as the contract covers both the roof waterproofing and the roof greening;
- the completion of the construction of the vegetation areas, if the planting or sowing work cannot subsequently be carried out.

### 16.2 Claims for defects

It is recommended to agree the following limitation periods for claims for defects:

- for the manufacture of the layer structure and technical equipment 4 years;
- for the manufacture of vegetation, provided that the contractor who manufactured the green roof was also commissioned with the development care 2 years.

If defects occur after acceptance within the period of limitation for claims for defects (e.g. plant failures), claims can only be made against the contractor if the defects are attributable to defective performance.

---

## 17 Testing

---

There are two different forms of testing:

- suitability tests and
- inspection tests.

The properties of substances

- for drainage layers, defined in table 15 and
- for vegetation strata, defined in table 16

are to be proven by suitability and inspection tests.

This has no bearing whatsoever on the need for self-monitoring by the manufacturer.

### 17.1 Test and investigation reports

In test and investigation reports for suitability and inspection testing on drainage-layer bulk materials and for growing media, the test results shall be compared with the characteristic values in tables 17-22 and evaluated. Designed, object-specific deviations from the control values must be taken into account. The reports must indicate the material composition. The results refer exclusively to the indicated production site.

The validity of the test and investigation reports for:

- growing media and drainage layer bulk materials, lasts for 3 years; the annual self-monitoring is to be proven on demand;
- the runoff coefficient and the runoff reference value, lasts for 5 years with the possibility to extend for another 5 years with proof of exactly the same composition and construction;
- the root resistance, lasts for 10 years with a maximum of two extensions in time periods of 5 years in cases of affirmation that the composition, production process and joining technique remain the same (See appendix C, section 9).

### 17.2 Structure of test and investigation reports

Investigation reports are to be structured in the following way:

- **Execution**  
Specification of client and/or manufacturer, type of sampling and sample quantities, production site (possibly encoded), delivery and inspection date and material composition according to the manufacturer and visual/manual inspection.
- **Methods**  
Short notification of the used examination methods.
- **Results**  
Representation of the mean in tabular form.
- **Evaluation**  
Verbal addressing using the requirement profiles in tables 17-22 and the particle size distribution ranges in s 3-8.

**Table 15: Proof of the properties of materials for drainage layers in the context of suitability and inspection testing**

No.	1	2		3	
1	Properties	Mineral bulk materials		Synthetic mats or membranes	
		Suitability Testing	Inspection Testing	Suitability Testing	Inspection Testing
2	Determination of the bulk density (dry/max. WKap.)	N	N	–	–
3	Determination of the load assumption (dry/max. WKap.)	–	–	N	N
4	Particle distribution	N	N	–	–
5	Weatherability	Z	–	N	–
6	Structure and layer stability	Z	–	–	–
7	Compressive behavior	–	–	N	–
8	Water permeability	N	–	N	–
9	Water storage capacity/ maximum water capacity	N	–	N	–
10	pH value	N	N	–	–
11	Salt content	N	N	N <sup>*)</sup>	–
12	Plant compatibility/ risk of phytotoxicity	Z/N <sup>*)</sup>	–	Z/N <sup>*)</sup>	–
13	Environmental compatibility	Z/N <sup>*)</sup>	–	Z/N <sup>*)</sup>	–
14	Fire characteristics	–	–	N <sup>*)</sup>	–
15	Material resistance	–	–	N <sup>*)</sup>	–

N = proof required

Z = Assurance based on years of experience and/or self-monitoring

\*) = Material-specific properties may need to be verified by means of a test certificate in accordance with valid standards and guidelines.

**Table 16: Proof of the properties of growing media in the scope of suitability and Inspection testing**

No.	1	2		3		4	
1	Properties	Intensive greening		Extensive greening		Single-layer construction for Intensive and Extensive greening	
		Suit-ability testing	Inspec-tion test-ing	Suit-ability testing	Inspec-tion test-ing	Suit-ability testing	Inspec-tion test-ing
2	Determination of the bulk density/ Load assumption (dry/max. WKap.)	N	N	N	N	N	N
3	Particle distribution	N	N	N	N	N	N
4	Organic matter content	N	N	N	N	N <sup>*)</sup>	N <sup>*)</sup>
5	Weatherability	Z	–	Z	–	Z	–
6	Structure and layer stability of bulk materials	Z	–	Z	–	Z	–
7	Compressive behavior of matts	Z/N <sup>*)</sup>	–	Z/N <sup>*)</sup>	–	Z/N <sup>*)</sup>	–
8	and panels						
9	Water permeability	N	N <sup>*)</sup>	N	N <sup>*)</sup>	N	–
10	Water storage capacity/ maximum water capacity	N	N <sup>*)</sup>	N	N <sup>*)</sup>	N	–
11	Air content	N	–	N	–	N	–
12	pH value	N	N	N	N	N	N
13	Salt content	N	N	N	N	N	N
14	Nutrient content	N	N <sup>*)</sup>	N	N <sup>*)</sup>	N <sup>*)</sup>	N <sup>*)</sup>
15	Seeds/plant parts capable of germination	Z	–	Z	–	Z	–
16	Plant compatibility	Z/N <sup>*)</sup>	–	Z/N <sup>*)</sup>	–	Z/N <sup>*)</sup>	–
17	Environmental compatibility	Z/N <sup>*)</sup>	–	Z/N <sup>*)</sup>	–	Z/N <sup>*)</sup>	–
18	Fire characteristics	–	–	N <sup>*)</sup>	–	N <sup>*)</sup>	–
19	Foreign materials	N	N	N	N	N	N

N = proof required

Z = Assurance based on years of experience and/or self-monitoring

\*) = Material-specific properties may need to be verified by means of a test certificate in accordance with valid standards and guidelines.

**Table 17: Requirements for the vegetation engineering properties of bulk materials for drainage layers**

(All values are derived from a condition of defined laboratory compaction)

No.	1	2		3
1	Properties	Requirement		Result
		Unit	Value	
<b>2</b>	<b>Particle distribution</b>			
<b>3</b>	– proportion of silting components, (d ≤ 0.063mm)	% mass	≤ 10	
<b>4</b>	<b>Bulk density (Volume weight) <sup>1)</sup></b>			
<b>5</b>	– in dry condition	g/cm <sup>3</sup>	–	
<b>6</b>	– at max. water capacity	g/cm <sup>3</sup>	–	
<b>7</b>	<b>Water/air balance</b>			
<b>8</b>	– total pore volume <sup>2)</sup>	vol. %	–	
<b>9</b>	– maximum water capacity	vol. %	–	
<b>10</b>	– water permeability mod. K <sub>f</sub>	mm/min	≥ 180	
<b>11</b>	– maximum water discharge <sup>2)</sup>	l/(s x m)	–	
<b>12</b>	<b>pH value, Salt content</b>			
<b>13</b>	– pH value (in CaCl <sub>2</sub> )		6.0 – 8.5	
<b>14</b>	– salt content (water extract) <sup>3)</sup>			
<b>15</b>	– for extensive greening	g/l	≤ 3.5	
<b>16</b>	– for intensive greening	g/l	≤ 2.5	
<b>17</b>	– salt content (gypsum extract) <sup>4)</sup>			
<b>18</b>	– for extensive greening	g/l	≤ 2.5	
<b>19</b>	– for intensive greening	g/l	≤ 1.5	

<sup>1)</sup> No requirements

<sup>2)</sup> Separate evidence where necessary

<sup>3)</sup> The value should be as low as possible

<sup>4)</sup> To be proven if needed

**Table 18: Requirements for vegetation engineering properties of growing media for multi-layer intensive greening (except turf greening)**

(All values are derived from a condition of defined laboratory compaction)

No.	1	2		3
1	Properties	Requirements		Result
		Unit	Value	
<b>2</b>	<b>Particle distribution <sup>1)</sup></b>			
<b>3</b>	– Proportion of silting components (d ≤ 0.063mm)	% mass	≤ 20	
<b>4</b>	– proportion of fine/medium gravel (d > 4mm)	% mass	≤ 40	
<b>5</b>	<b>Bulk density (Volume weight) <sup>2)</sup></b>			
<b>6</b>	– in dry condition	g/cm <sup>3</sup>	–	
<b>7</b>	– at max. water capacity	g/cm <sup>3</sup>	–	
<b>8</b>	<b>Water/air balance</b>			
<b>9</b>	– total pore volume <sup>2)</sup>	vol. %	–	
<b>10</b>	– maximum water capacity	vol. %	45 – 65	
<b>11</b>	– air capacity at maximum water capacity	vol. %	≥ 10	
<b>12</b>	– air capacity at pF 1.8	vol. %	≥ 20	
<b>13</b>	– water permeability mod. K <sub>f</sub>	mm/min	0.3 – 30.0	
<b>14</b>	<b>pH value, salt content</b>			
<b>15</b>	– pH value (in CaCl <sub>2</sub> )		6.0 – 8.5	
<b>16</b>	– salt content (water extract) <sup>3)</sup>	g/l	≤ 2.5	
<b>17</b>	– salt content (gypsum extract) <sup>4)</sup>	g/l	≤ 1.5	
<b>18</b>	<b>Organic Substance</b>			
<b>19</b>	– organic matter content	g/l	≤ 90	
<b>20</b>	<b>Nutrients <sup>5)</sup></b>			
<b>21</b>	– plant-available nutrients			
<b>22</b>	– Nitrogen (N) (in CaCl <sub>2</sub> )	mg/l	≤ 80	
<b>23</b>	– Phosphorus (P <sub>2</sub> O <sub>5</sub> ) (in CAL)	mg/l	≤ 200	
<b>24</b>	– Potassium (K <sub>2</sub> O) (in CAL)	mg/l	≤ 700	
<b>25</b>	– Magnesium (Mg) (in CaCl <sub>2</sub> )	mg/l	≤ 200	
<b>26</b>	– plant-available nutrients (in CAT)			
<b>27</b>	– Nitrogen (N)	mg/l	≤ 80	
<b>28</b>	– Phosphorus (P <sub>2</sub> O <sub>5</sub> )	mg/l	≤ 50	
<b>29</b>	– Potassium (K <sub>2</sub> O)	mg/l	≤ 500	
<b>30</b>	– Magnesium (Mg)	mg/l	≤ 200	

(Table 18 continued)

No.	1	2		3
1	Properties	Requirements		Result
		Unit	Value	
<b>31</b>	<b>Foreign material</b>			
<b>32</b>	– diameter > 6 mm			
<b>33</b>	– tiles, glass, ceramic and similar.	% mass	≤ 0.3	
<b>34</b>	– metal, plastic	% mass	≤ 0.1	
<b>35</b>	– total area of plastics	cm <sup>2</sup> /l	≤ 10	

- 1) The particle size diagram is to be entered into the specified particle size distribution range according to 4 (see section 12.2.2)
- 2) No requirements
- 3) The value should be as low as possible
- 4) To be proven if needed
- 5) Either in CAL/Calcium chloride or CAT

**Table 19: Requirements for vegetation engineering properties of growing media for multi-layer extensive greening**

(All values are derived from a condition of defined laboratory compaction)

No.	1	2		3
1	Properties	Requirements		Result
		Unit	Value	
<b>2</b>	<b>Particle distribution <sup>1)</sup></b>			
3	– Proportion of silting components (d ≤ 0.063mm)	% mass	≤ 15	
4	– proportion of fine/medium gravel (d > 4mm)	% mass	≤ 50	
<b>5</b>	<b>Bulk density (Volume weight) <sup>2)</sup></b>			
6	– in dry condition	g/cm <sup>3</sup>	–	
7	– at max. water capacity	g/cm <sup>3</sup>	–	
<b>8</b>	<b>Water/air balance</b>			
9	– total pore volume <sup>2)</sup>	vol. %	–	
10	– maximum water capacity	vol. %	35 – 65	
11	– air capacity at maximum water capacity	vol. %	≥ 10	
12	– air capacity at pF 1.8	vol. %	≥ 20	
13	– water permeability mod. K <sub>f</sub>	mm/min	0.6 – 70	
<b>14</b>	<b>pH value, salt content</b>			
15	– pH value (in CaCl <sub>2</sub> )		6.0 – 8.5	
16	– salt content (water extract) <sup>3)</sup>	g/l	≤ 3.5	
17	– salt content (gypsum extract) <sup>4)</sup>	g/l	≤ 2.5	
<b>18</b>	<b>Organic Substance</b>			
19	– organic matter content	g/l	≤ 65	
<b>20</b>	<b>Nutrients <sup>5)</sup></b>			
21	– plant-available nutrients			
22	– Nitrogen (N) (in CaCl <sub>2</sub> )	mg/l	≤ 80	
23	– Phosphorus (P <sub>2</sub> O <sub>5</sub> ) (in CAL)	mg/l	≤ 200	
24	– Potassium (K <sub>2</sub> O) (in CAL)	mg/l	≤ 700	
25	– Magnesium (Mg) (in CaCl <sub>2</sub> )	mg/l	≤ 200	
26	– plant-available nutrients (in CAT)			
27	– Nitrogen (N)	mg/l	≤ 80	
28	– Phosphorus (P <sub>2</sub> O <sub>5</sub> )	mg/l	≤ 50	
29	– Potassium (K <sub>2</sub> O)	mg/l	≤ 500	
30	– Magnesium (Mg)	mg/l	≤ 200	

(Table 19 continued)

No.	1	2		3
1	Properties	Requirements		Result
		Unit	Value	
<b>31</b>	<b>Foreign material</b>			
<b>32</b>	– diameter > 6 mm			
<b>33</b>	– tiles, glass, ceramic and similar.	% mass	≤ 0.3	
<b>34</b>	– metal, plastic	% mass	≤ 0.1	
<b>35</b>	– total area of plastics	cm <sup>2</sup> /l	≤ 10	

- 1) The particle size diagram is to be entered into the specified particle size distribution range according to figure 4 (see section 12.2.2)
- 2) No requirements
- 3) The value should be as low as possible
- 4) To be proven if needed
- 5) Either in CAL/Calcium chloride or CAT

**Table 20: Requirements for vegetation engineering properties of growing media for single-layer intensive and extensive greening (except turf greening)**

(All values are derived from a condition of defined laboratory compaction)

No.	1	2		3
		Requirements		Result
1	Properties	Unit	Value	
2	<b>Particle distribution</b> <sup>1)</sup>			
3	– Proportion of silting components (d ≤ 0.063mm)	% mass	≤ 10	
4	– proportion of fine/medium gravel (d > 4mm)	% mass	≤ 75	
5	<b>Bulk density (Volume weight)</b> <sup>2)</sup>			
6	– in dry condition	g/cm <sup>3</sup>	–	
7	– at max. water capacity	g/cm <sup>3</sup>	–	
8	<b>Water/air balance</b>			
9	– total pore volume <sup>2)</sup>	vol. %	–	
10	– maximum water capacity			
11	– intensive greening	vol. %	30 – 65	
12	– extensive greening	vol. %	20 – 65	
13	– air capacity at maximum water capacity	vol. %	≥ 10	
14	– water permeability mod. K <sub>f</sub>	mm/min	60 – 400	
15	<b>pH value, salt content</b>			
16	– pH value (in CaCl <sub>2</sub> )		6.0 – 8.5	
17	– intensive greening			
18	– salt content (water extract) <sup>3)</sup>	g/l	≤ 2.5	
19	– salt content (gypsum extract) <sup>4)</sup>	g/l	≤ 1.5	
20	– extensive greening			
21	– salt content (water extract) <sup>3)</sup>	g/l	≤ 3.5	
22	– salt content (gypsum extract) <sup>4)</sup>	g/l	≤ 2.5	
23	<b>Organic matter</b>			
24	– organic matter content	g/l	≤ 40	
25	<b>Nutrients</b> <sup>5)</sup>			
26	– plant-available nutrients			
27	– Nitrogen (N) (in CaCl <sub>2</sub> )	mg/l	≤ 80	
28	– Phosphorus (P <sub>2</sub> O <sub>5</sub> ) (in CAL)	mg/l	≤ 200	
29	– Potassium (K <sub>2</sub> O) (in CAL)	mg/l	≤ 700	
30	– Magnesium (Mg) (in CaCl <sub>2</sub> )	mg/l	≤ 200	

(Table 20 continued)

No.	1	2		3
1	Properties	Requirements		Result
		Unit	Value	
<b>31</b>	<b>Nutrients</b> <sup>5)</sup>			
<b>32</b>	– plant-available nutrients (in CAT)			
<b>34</b>	– Nitrogen (N)	mg/l	≤ 80	
<b>35</b>	– Phosphorus (P <sub>2</sub> O <sub>5</sub> )	mg/l	≤ 50	
<b>36</b>	– Potassium (K <sub>2</sub> O)	mg/l	≤ 500	
<b>37</b>	– Magnesium (Mg)	mg/l	≤ 200	
<b>38</b>	<b>Foreign materials</b>			
<b>39</b>	– diameter > 6 mm			
<b>40</b>	– tiles, glass, ceramic and similar.	% mass	≤ 0.3	
<b>41</b>	– metal, plastic	% mass	≤ 0.1	
<b>42</b>	– total area of plastics	cm <sup>2</sup> /l	≤ 10	

- 1) The particle size diagram is to be entered into the specified particle size distribution range according to figure 4 (see section 12.2.2)
- 2) No requirements
- 3) The value should be as low as possible
- 4) To be proven if needed
- 5) Either in CAL/Calcium chloride or CAT

**Table 21: Requirements for the vegetation engineering properties of growing media for turf greening with multi-layered construction**

(All values are derived from a condition of defined laboratory compaction)

No.	1	2		3
1	Properties	Requirements		Result
		Unit	Value	
2	<b>Particle distribution</b> <sup>1)</sup>			
3	– Proportion of silting components (d ≤ 0.063mm)	% mass	≤ 20	
4	– proportion of fine/medium gravel (d > 4mm)	% mass	≤ 18	
5	<b>Bulk density (Volume weight)</b> <sup>2)</sup>			
6	– in dry condition	g/cm <sup>3</sup>	–	
7	– at max. water capacity	g/cm <sup>3</sup>	–	
8	<b>Water/air balance</b>			
9	– total pore volume <sup>2)</sup>	vol. %	–	
10	– maximum water capacity	vol. %	35 – 65	
11	– air capacity at maximum water capacity	vol. %	≥ 10	
12	– air capacity at pF 1.8	vol. %	≥ 20	
13	– water permeability mod. K <sub>f</sub>	mm/min	0.6 – 70	
14	<b>pH value, salt content</b>			
15	– pH value (in CaCl <sub>2</sub> )		5.5 – 7.5	
16	– salt content (water extract) <sup>3)</sup>	g/l	≤ 1.5	
17	– salt content (gypsum extract) <sup>4)</sup>	g/l	≤ 1.0	
18	<b>Organic Substance</b>			
19	– organic matter content	g/l	≤ 65	
20	<b>Nutrients</b> <sup>5)</sup>			
21	– plant-available nutrients			
22	– Nitrogen (N) (in CaCl <sub>2</sub> )	mg/l	≤ 80	
23	– Phosphorus (P <sub>2</sub> O <sub>5</sub> ) (in CAL)	mg/l	≤ 200	
24	– Potassium (K <sub>2</sub> O) (in CAL)	mg/l	≤ 700	
25	– Magnesium (Mg) (in CaCl <sub>2</sub> )	mg/l	≤ 200	
26	– plant-available nutrients (in CAT)			
27	– Nitrogen (N)	mg/l	≤ 80	
28	– Phosphorus (P <sub>2</sub> O <sub>5</sub> )	mg/l	≤ 50	
29	– Potassium (K <sub>2</sub> O)	mg/l	≤ 500	
30	– Magnesium (Mg)	mg/l	≤ 200	

**(Table 21 continued)**

No.	1	2		3
1	Properties	Requirements		Result
		Unit	Value	
<b>31</b>	<b>Foreign materials</b>			
<b>32</b>	– diameter > 6 mm			
<b>33</b>	– tiles, glass, ceramic and similar.	% mass	≤ 0.3	
<b>34</b>	– metal, plastic	% mass	≤ 0.1	
<b>35</b>	– total area of plastics	cm <sup>2</sup> /l	≤ 10	

- 1) The particle size diagram is to be entered into the specified particle size distribution range according to figure 4 (see section 12.2.2)
- 2) No requirements
- 3) The value should be as low as possible
- 4) To be proven if needed
- 5) Either in CAL/Calcium chloride or CAT

**Table 22: Requirements for the vegetation engineering properties of growing media for turf greening with single-layered construction<sup>6</sup>**

(All values are derived from a condition of defined laboratory compaction)

No.	1	2		3
1	Properties	Requirements		Result
		Unit	Value	
2	<b>Particle distribution</b> <sup>1)</sup>			
3	– Proportion of silting components (d ≤ 0.063mm)	% mass	≤ 10	
4	– proportion of fine/medium gravel (d > 4mm)	% mass	≤ 30	
5	<b>Bulk density (Volume weight)</b> <sup>2)</sup>			
6	– in dry condition	g/cm <sup>3</sup>	–	
7	– at max. water capacity	g/cm <sup>3</sup>	–	
8	<b>Water/air balance</b>			
9	– total pore volume <sup>2)</sup>	vol. %	–	
10	– maximum water capacity	vol. %	30 – 65	
11	– air capacity at maximum water capacity	vol. %	≥ 10	
12	– air capacity at pF 1.8	vol. %	≥ 20	
13	– water permeability mod. K <sub>f</sub>	mm/min	60 – 200	
14	<b>pH value, salt content</b>			
15	– pH value (in CaCl <sub>2</sub> )		5.5 – 7.5	
16	– salt content (water extract) <sup>3)</sup>	g/l	≤ 1.5	
17	– salt content (gypsum extract) <sup>4)</sup>	g/l	≤ 1.0	
18	<b>Organic Substance</b>			
19	– organic matter content	g/l	≤ 40	
20	<b>Nutrients</b> <sup>5)</sup>			
21	– plant-available nutrients			
22	– Nitrogen (N) (in CaCl <sub>2</sub> )	mg/l	≤ 80	
23	– Phosphorus (P <sub>2</sub> O <sub>5</sub> ) (in CAL)	mg/l	≤ 200	
24	– Potassium (K <sub>2</sub> O) (in CAL)	mg/l	≤ 700	
25	– Magnesium (Mg) (in CaCl <sub>2</sub> )	mg/l	≤ 200	
26	– plant-available nutrients (in CAT)			
27	– Nitrogen (N)	mg/l	≤ 80	
28	– Phosphorus (P <sub>2</sub> O <sub>5</sub> )	mg/l	≤ 50	
29	– Potassium (K <sub>2</sub> O)	mg/l	≤ 500	
30	– Magnesium (Mg)	mg/l	≤ 200	

(Table 22 continued)

No.	1	2		3
1	Properties	Requirements		Result
		Unit	Value	
<b>31</b>	<b>Foreign materials</b>			
<b>32</b>	– diameter > 6 mm			
<b>33</b>	– tiles, glass, ceramic and similar.	% mass	≤ 0.3	
<b>34</b>	– metal, plastic	% mass	≤ 0.1	
<b>35</b>	– total area of plastics	cm <sup>2</sup> /l	≤ 10	

- 1) The particle size diagram is to be entered into the specified particle size distribution range according to figure 4 (see section 12.2.2)
- 2) No requirements
- 3) The value should be as low as possible
- 4) To be proven if needed
- 5) Either in CAL/Calcium chloride or CAT
- 6) recommended in combination with turfs

---

## Information Sources

---

### **BEUTH VERLAG GMBH**

Burggrafenstr. 6, D-10787 Berlin  
Tel.: + 49 30/26010, Fax: + 49 30/26011260  
E-Mail: [info@beuth.de](mailto:info@beuth.de),  
Homepage: [www.beuth.de](http://www.beuth.de)

### **BUNDESFACHABTEILUNG BAUWERKSABDICHTUNG IM HAUPTVERBAND DER DEUTSCHEN BAUINDUSTRIE E. V. (HDB)**

Kurfürstenstraße 129, 10785 Berlin  
Tel.: + 49 30/21286-0, Fax: + 49 30/21286-240  
E-Mail: [info@bauindustrie.de](mailto:info@bauindustrie.de),  
Homepage: [www.bauindustrie.de](http://www.bauindustrie.de)

### **BUNDESVERBAND GEBÄUDE GRÜN E.V. (BUGG)**

Albrechtstraße 13, D-10117 Berlin  
Tel.: +49 (0) 30 / 400 54 102  
E-Mail: [info@bugg.de](mailto:info@bugg.de), Homepage: [www.bugg.de](http://www.bugg.de), [www.gebaeudegruen.info](http://www.gebaeudegruen.info)

**Note:** In may 2018 ‚Deutscher Dachgärtnerverband e.V. (DDV)‘ and ‚Fachvereinigung Bauwerksbegrünung e.V (FBB)‘ have merged into ‚Bundesverband Gebäude Grün e. V. (BuGG)‘.

### **DEUTSCHE GESETZLICHE UNFALLVERSICHERUNG E.V. (DGUV)**

Glinkastraße 40, 10117 Berlin  
Tel.: + 49 30 288763800 (Zentrale), FAX: + 49 30 288763808  
E-Mail: [info@dguv.de](mailto:info@dguv.de);  
Homepage: [www.dguv.de](http://www.dguv.de)

### **DEUTSCHES INSTITUT FÜR GÜTESICHERUNG UND KENNZEICHNUNG E. V. (RAL)**

Siegburger Straße 39, 53757 Sankt Augustin  
Tel.: + 49 2241/1605-0, Fax: + 49 2241/1605-11  
E-Mail: [RAL-Institut@RAL.de](mailto:RAL-Institut@RAL.de),  
Homepage: [www.ral.de](http://www.ral.de)

### **FORSCHUNGSGESELLSCHAFT LANDSCHAFTSENTWICKLUNG LANDSCHAFTSBAU E. V. (FLL)**

Friedensplatz 4, D-53111 Bonn  
Tel.: + 49 228/965010-0, Fax: + 49 228/965010-20  
E-Mail: [info@fll.de](mailto:info@fll.de),  
Homepage: [www.fll.de](http://www.fll.de)

### **FORSCHUNGSGESELLSCHAFT FÜR STRAßEN UND VERKEHRSWESEN E. V. (FGSV)**

Wesseling Str. 17, D-50999 Köln  
Tel.: + 49 2236/384630, Fax: + 49 2236/384640  
E-Mail: [info@fgsv-verlag.de](mailto:info@fgsv-verlag.de),  
Homepage: [www.fgsv-verlag.de](http://www.fgsv-verlag.de)

**SOZIALVERSICHERUNG FÜR LANDWIRTSCHAFT, FORSTEN UND GARTENBAU – SVLFG  
(GARTENBAU–BERUFGENOSSENSCHAFT)**

Frankfurter Straße 126, 34121 Kassel

Tel.: + 49 561 928-0, Fax: + 49 561 9359-217

E-Mail: [poststelle@svlfg.de](mailto:poststelle@svlfg.de),

Homepage: [www.svlfg.de](http://www.svlfg.de)

**VERBAND DEUTSCHER LANDWIRTSCHAFTLICHER UNTERSUCHUNGS- UND FORSCHUNGSANSTALTEN  
(VDLUFA)**

c/o LUFA Speyer

Obere Langgasse 40, 67346 Speyer

Tel.: + 49 6232-136-121, Fax: + 49 6232-136-122

E-mail: [info@vdlufa.de](mailto:info@vdlufa.de),

Homepage: [www.vdlufa.de](http://www.vdlufa.de)

**ZENTRALVERBAND DES DEUTSCHEN DACHDECKERHANDWERKS E. V. (ZVDH)**

- Fachverband Dach-, Wand- und Abdichtungstechnik -  
Fritz-Reuter-Str. 1, 50968 Köln

Tel.: + 49 221/398038-0, Fax: + 49 221/398038-99

E-Mail: [zvdh@dachdecker.de](mailto:zvdh@dachdecker.de),

Homepage: [www.dachdecker.org](http://www.dachdecker.org)

## Appendix A: Informative orientation values for load assumptions and water storage

The values in the following tables are orientation values for the load assumptions and water storage. For planning and implementation, it is necessary to use the manufacturer's product-specific parameters.

The values needed for the structural load assumption calculation in KN/m<sup>2</sup> come from a simplified method of dividing the given area load in Kg/m<sup>2</sup> by 100

**Table 23: Load assumptions and water storage of bulk materials, mats and panels for drainage layers as well as for protective layers at maximum water capacity**

1	2	3		4
Material group/ material type	Particle in mm	Load assumption per 1 cm layer thickness		Medium water storage per 1 cm layer thickness in l/m <sup>2</sup>
		in KN/m <sup>2</sup>	in kg/m <sup>2</sup>	
<b>Mineral bulk materials</b>				
Lava	2/8 – 2/12	0.12 – 0.14	12.0 – 14.0	2.6
Lava	4/8 – 4/12	0.11 – 0.12	11.0 – 12.0	2.0
Lava	8/12 – 8/16	0.10 – 0.14	10.0 – 14.0	1.5
Pumice	2/8 – 2/12	0.08 – 0.10	8.0 – 10.0	3.8
Pumice	8/16 – 8/20	0.11 – 0.12	11.0 – 12.0	2.7
Expanded clay, crushed	2/8 – 2/10	0.05 – 0.07	5.0 – 7.0	2.4
Expanded clay, crushed	4/8 – 4/10	0.06 – 0.08	6.0 – 8.0	2.5
Expanded clay, uncrushed	4/8	0.06 – 0.08	6.0 – 8.0	1.4
Expanded clay, uncrushed	8/16	0.05 – 0.07	5.0 – 7.0	1.0
Expanded slate, crushed	2/8 – 2/10	0.08 – 0.10	8.0 – 10.0	2.3
Expanded slate, crushed	4/8 – 4/10	0.07 – 0.08	7.0 – 8.0	1.3
Crushed brick	4/8	0.12 – 0.14	12.0 – 14.0	2.3
Recycled brick	4/8	0.13 – 0.15	13.0 – 15.0	2.3
Crushed roof tiles	4/8	0.13 – 0.15	13.0 – 15.0	1.1
Basalt gravel	2/8	0.15 – 0.17	15.0 – 17.0	0.7
Dolomite gravel	5/8	0.15 – 0.16	15.0 – 16.0	0.7
Granite gravel	5/8	0.14 – 0.15	14.0 – 15.0	2.0
Tuff gravel	2/8 – 2/12	0.11 – 0.12	11.0 – 12.0	2.6
Gravel	2/8	0.16 – 0.17	16.0 – 17.0	0.9
Gravel	8/16	0.16 – 0.18	16.0 – 18.0	0.8
Gravel	16/32	0.16 – 0.18	16.0 – 18.0	0.6

(Table 23 continued)

1	2	3		4
Material group/ material type	Layer thickness in cm	Load assumption per 1 cm layer thickness		Medium water storage of the whole layer in l/m <sup>2</sup>
		in KN/m <sup>2</sup>	in kg/m <sup>2</sup>	
<b>Drainage mats</b>				
Structure geotextile mats	1.0	0.050 – 0.070	5.0 – 7.0	5.0
Studded plastic mats	1.2	0.019 – 0.021	1.9 – 2.1	0.4
Fibre-type woven mats	1.5	0.008 – 0.019	0.8 – 1.9	0.4
Fibre-type woven mats	2.2	0.022 – 0.023	2.2 – 2.3	1.2
<b>Drainage panels</b>				
Hard plastic profile panels	2.5	0.040 – 0.050	4.0 – 5.0	3.1
Hard plastic profile panels	4.0	0.060 – 0.070	6.0 – 7.0	4.4
Hard plastic profile panels	6.0	0.025 – 0.260	2.5 – 26.0	24.5
Hard foam profile panels	5.0	0.020 – 0.030	2.0 – 3.0	2.1
Hard foam profile panels	7.5	0.030 – 0.040	3.0 – 4.0	2.0
Insulation profile panels	6.5	0.040 – 0.050	4.0 – 5.0	3.0
Insulation profile panels	12.0	0.050 – 0.060	5.0 – 6.0	3.0
<b>Drainage and substrate panels</b>				
Modified hard foam	3.6	0.050 – 0.060	5.0 – 6.0	18.6
<b>Protective layers</b>				
Geotextile 300 g/m <sup>2</sup>	0.3	0.025 – 0.035	2.5 – 3.5	2.7
Geotextile 500 g/m <sup>2</sup>	0.5	0.050 – 0.060	5.0 – 6.0	4.5
Geotextile 800 g/m <sup>2</sup>	0.8	0.065 – 0.075	6.5 – 7.5	5.9
Protective panels - pored	1.0	0.180 – 0.190	18.0 – 19.0	1.1
Protective panels - studded	2.0	0.110 – 0.130	11.0 – 13.0	0.5

**Table 24: Load assumptions and water storage of vegetation strata at maximum water capacity**

1	2		3
Substrate group Substrate type	Load assumption per 1 cm layer thickness		Medium water storage per 1 cm layer thickness in l/m <sup>2</sup>
	in KN/m <sup>2</sup>	in kg/m <sup>2</sup>	
<b>Substrates for intensive greening</b>			
Soil/Mineral mixtures	0.16 – 0.19	16.0 – 19.0	3.0
Soil/hard foam mixtures	0.13 – 0.15	13.0 – 15.0	2.5
Soil/organic matter mixtures	0.15 – 0.17	15.0 – 17.0	3.5
Peat/mineral mixtures	0.11 – 0.12	11.0 – 12.0	7.5
Compost/mineral mixtures	0.11 – 0.13	11.0 – 13.0	6.5
<b>Substrates for extensive greening</b>			
Lava mixtures	0.145 – 0.165	14.5 – 16.5	4.4
Lava/pumice mixtures	0.125 – 0.130	12.5 – 13.0	4.2
Lava/pumice/dolomite mixtures	0.145 – 0.165	14.5 – 16.5	3.9
Lava/pumice/tuff mixtures	0.145 – 0.165	14.5 – 16.5	4.7
Sand/lava mixtures	0.160 – 0.175	16.0 – 17.5	5.0
Expanded clay mixtures	0.100 – 0.130	10.0 – 13.0	4.9
Expanded slate mixtures	0.110 – 0.130	11.0 – 13.0	4.9
Brick mixtures	0.130 – 0.160	13.0 – 16.0	3.9
Slate slag mixtures	0.140 – 0.150	14.0 – 15.0	4.2
Mining slag mixtures	0.140 – 0.150	14.0 – 15.0	3.1
<b>Substrate single-layer construction for intensive and extensive greening</b>			
Lava mixtures	0.115 – 0.135	11.5 – 13.5	1.7
Pumice mixtures	0.075 – 0.095	7.5 – 9.5	3.5
Lava/pumice mixtures	0.120 – 0.130	12.0 – 13.0	2.6
Lava/pumice/tuff mixtures	0.130 – 0.150	13.0 – 15.0	2.8
Expanded clay mixtures	0.060 – 0.070	6.0 – 7.0	2.3
Expanded slate mixtures	0.080 – 0.100	8.0 – 10.0	2.3
Light mineral/pumice mixtures	0.085 – 0.100	8.5 – 10.0	3.3
Light-clay granulate	0.080 – 0.085	8.0 – 8.5	4.1
Brick mixtures	0.115 – 0.135	11.5 – 13.5	2.4
Slate slag mixtures	0.115 – 0.135	11.5 – 13.5	4.0
Mining slag mixtures	0.130 – 0.150	13.0 – 15.0	2.5

**Table 25: Load assumptions and water storage of substrate panels, vegetation mats and water storage layers at maximum water capacity.**

1	2	3		4
Substrate group Substrate type	layer thick- ness in cm	Load assumption of the whole layer		Medium water storage of the whole layer in l/m <sup>2</sup>
		in KN/m <sup>2</sup>	in kg/m <sup>2</sup>	
<b>Substrate panels</b>				
Panels from mod. hard foam	3.0	0.23 – 0.25	23.0 – 25.0	18.6
Panels from composite foam	5.0	0.31 – 0.33	31.0 – 33.0	31.9
Panels from mineral wool	6.0	0.65 – 0.68	65.0 – 68.0	35.0
<b>Vegetation mats<sup>1)</sup></b>				
Fiber-woven mats	2.0	0.280 – 0.300	28.0 – 30.0	13.5
Fiber-woven/geotextile mats	3.0	0.370 – 0.395	37.0 – 39.5	17.4
Natural fiber mats	2.0	0.210 – 0.230	21.0 – 23.0	11.0
Geotextile mats	3.0	0.260 – 0.280	26.0 – 28.0	24.1
Roof sods	2.5	0.380 – 0.420	38.0 – 42.0	16.3
<b>Seed mats</b>				
Seed composite mats	3.0	0.27 – 0.28	27.0 – 28.0	26.0
<b>Water storage layers</b>				
Storage geotextiles 1200 g/m <sup>2</sup>	1.0	0.095 – 0.105	9.5 – 10.5	9.0
Storage geotextiles 1600 g/m <sup>2</sup>	2.0	0.160 – 0.170	16.0 – 17.0	15.1
Mineral wool mats	2.5	0.230 – 0.250	23.0 – 25.0	23.4
Mineral wool mats	5.0	0.420 – 0.440	42.0 – 44.0	40.0
Composite foam panels	2.0	0.150 – 0.160	15.0 – 16.0	12.8

<sup>1)</sup> Including the vegetation

**Table 26: Last assumptions of the vegetation forms**

1	2	
Vegetation form	Load assumption	
	in KN/ m <sup>2</sup>	in kg/ m <sup>2</sup>
<b>Extensive greening</b>		
Moss-sedum greening	0.10	10
Sedum-moss-herb greening	0.10	10
Sedum-herb-grass greening	0.10	10
Grass-herb greening (dry grass)	0.10	10
<b>Simple intensive greening</b>		
Grass-herb greening (grass roof, poor grassland)	0.15	15
Wild perennial-tree/shrub greening	0.10	10
Trees/shrubs-perennials greening	0.15	15
tree/shrub greening (to 150 cm high)	0.20	20
<b>Intensive greening</b>		
Turf	0.05	5
Low perennials and trees/shrubs	0.10	10
Perennials and bushes to 150 cm height	0.20	20
Bushes to 3 m height	0.30	30
Large bushes <sup>1)</sup> to 6 m height	0.40	40
Small trees <sup>1)</sup> to 10 m height	0.60	60
Trees <sup>1)</sup> to 15 m height	1.50	150

<sup>1)</sup> Values referring the area of the drip line

---

## Appendix B: Investigative methods for vegetation substrate and drainage bulk materials for green roofs

---

The methods, in their agreed (VDLUFA), standardized (DIN, DIN EN, ISO) or modified and described forms, to be used to determine the properties/reference values are described below. In those isolated cases where the methods employed vary from those shown, this must be indicated clearly in any investigation reports and a comparison of the deviations to the standard results must be made.

The method for determining the physical soil properties in the previous DIN EN can only be partially applied because it was developed for testing garden substrates and is not applicable for mineral-based substrate testing.

No values or standards have been given for testing the environmental compatibility. The VDLUFA describes methods for testing individual parameters, which can be applied as necessary. The RAL-quality assurance – GZ 250/6 describes individual parameters for substrates and drainage layer materials. The measured values can be declared where the analysis method is given.

### Sample testing

When sample test are required by the client, they should be carried out in the following way:

- sample testing in a non-constructed state

The samples for compatibility and suitability testing in a non-constructed state are oriented to the requirements of the RAL-GZ 250/6, no. 1.1.4.1.3.1, sample testing at the production site. They can extend to production or delivery batches which are on the construction site and deemed to have visual or manual deviations.

- Sample testing in a constructed state

For compatibility and suitability testing in a constructed state, mixed samples are to be taken. A mixed sample consists of 15 single samples which are taken from representative positions spread over the surface to be tested.

Where the substrate/bulk material is deemed to be homogenous following a visual or manual check, one test sample is adequate.

Should a substrate/bulk material have separated due to different delivery batches or laying techniques, then a mixed sample must be taken from each distinguishable partial area.

For a representative examination of the total greened area in respect to the homogeneity of the substrate/bulk material and depending on the size of the area, the following distribution of samples should be taken:

- up to 500 m<sup>2</sup> = 1 sample;
- from > 500 m<sup>2</sup> to ≤ 1000 m<sup>2</sup> = 2 samples;
- from each further 1000 m<sup>2</sup> = 1 sample from each.

The location where each sample is taken must be located on a plan.

If the sample is taken from an area that has already been greened, then the vegetation, mulch and top 2 – 3 cm of the vegetation stratum must be removed. The sample taken must then comprise of material from the entire depth of the individual layers.

The individual samples must be mixed carefully. 10 liters of this material in a closed container is required for a limited analysis and 25 liters for a full analysis. The container should be labelled with the address of the sender, location from where the sample was taken, details of the manufacturer or the location of production and the date.

**Table 27: Overview of investigation methods for growing media and drainage-layer bulk materials for green roofs**

Property Reference value	Description of method	Comments/notes
<b>Particle size distribution</b>  [% mass]	DIN EN ISO 17892-4 Geotechnical investigation and testing - Laboratory testing of soil - Part 4: Determination of particle size distribution (ISO 17892-4:2016); German version EN ISO 17892-4:2016	At the fraction $d > 2$ mm, check whether clay crumbs are present. If this is the case, the sample should be soaked, the clay should be slurried off and added to the fraction $d < 2$ mm.  The sieving is carried out after the sample has been washed DIN EN 13039.  In the investigation, the standard sieve set is supplemented by sieves with a mesh size of 12.5 mm and 16.0 mm, and in the case of turf substrates by a sieve with a mesh size of 8.0 mm.
<b>Bulk density</b> (Weight) - fresh, moist $\rho_f$ - dry $\rho_t$ - at maximum water capacity $\rho_{wk}$  [g/cm <sup>3</sup> u. g/Liter]  (see attachment B.1 to appendix B)	Determination in cylinders of 15 cm $\varnothing$ and at approximately 10 cm sample height in the compressed state	Based on DIN 18127 Soil, investigation and testing - Proctor-test and on the determination of water permeability according to DIN 18035 Sports grounds - Part 4: Sports turf areas; in the older edition of October 1974.
<b>Water content</b>  [% mass Vol. %]	VDLUFA C 1.1.1 Determination of the water content of soil samples by gravimetry (Oven method)	
<b>Maximum water capacity</b> $WK_{max}$  [Vol. %]  (see attachment B.1 to appendix B)	Determination in cylinders of 15 cm $\varnothing$ and at approximately 10 cm sample height in the compressed state	see bulk density
<b>Water permeability</b> mod. $K_f$  [mm/min]  (see attachment B.3 to appendix B)	Determination in cylinders of 15 cm $\varnothing$ and at approximately 10 cm sample height in the compressed state and at maximum water capacity	see bulk density
<b>Horizontal water permeability</b>  [l/s x m]	ISO 12958 Geotextiles and geotextile-related products - Determination of water flow capacity in their plane	Applies to geosynthetics. Determination is analogous.

(Table 27 continued)

Property Reference value	Description of method	Comments/notes
<b>Total pore volume</b> TPV [Vol. %]	VDLUFA C 4.2 Determination of porosity in soils	The determination cannot be applied to substrates containing or consisting of organic-synthetic foams.
<b>Water binding</b> at pF 1,8  [Vol. %]	VDLUFA C 4.3.1 Investigating pore size distribution in soils using negative-pressure technique  VDLUA C 4.3.2 Investigating pore size distribution in soils using positive-pressure technique  ISO 11274 Soil quality determination of water retention characteristics – lab. methods	To determine the air capacity in substrates.  The determination is normally ac- cording to methods 5 and 7.
<b>Air capacity</b> – at $WK_{max}$  – at pF 1,8  [Vol. %]	Difference between total pore volume and water content at max- imum water capacity  Difference between total pore volume and water content at pF 1.8	The provision shall be supple- mented if the air capacity at maxi- mum water capacity falls below the specified minimum value.
<b>pH value</b>	VDLUFA A 5.1.1 Determination of pH value (in CaCl <sub>2</sub> )  DIN EN 13037 Soil improvement products and cultivating substrates – determin- ing the pH-values	Sample amounts see footnote 1  For determination of the pH-value according to DIN EN 13037, there are currently no reference values, so that no requirements can be given.

- 1) The determination of the pH value, the salt content and the soluble nutrients, due to the coarse particles, is based on the sample weights of the VDLUFA regulations and DIN EN methods, the threefold weighing quantity of non-sieved and unground material is to be determined.

(Table 27 continued)

Property Reference value	Description of method	Comments/notes
<p><b>Salt content</b></p> <p>[g/Liter]</p>	<p>VDLUFA A. 10.1.1 Determining the salt content in soils, horticultural soils and substrates</p> <p>VDLUFA A 13.4.2 Determining the salt content in soils used for horticulture, in horticultural soils and substrates in an extract with saturated gypsum (see A 10.1.2)</p> <p>DIN EN 13038 Soil improvers and growing media - Determination of electrical conductivity</p>	<p>Conversion from mg/100 g substrate following the VDLUFA or manufacturer's guidelines. Determining the apparent bulk density (dry) in a compacted condition following the methods described in attachment B.1 to appendix B and examining the salt content through a conversion as KCl in g/litre</p> <p>Sample volumes see footnote 2</p> <p>To be carried out additionally if the salt content determined as per VDLUFA A 10.1.1 exceeds the upper limits</p> <p>For determination of the conductivity according to DIN EN 13038, there are currently no reference values, so that no requirements can be given</p>
<p><b>Organic matter content</b></p> <p>[g/Liter]</p>	<p>DIN EN 13039 Soil improvers and growing media - Determination of organic matter content and ash</p>	<p>Due to the particle coarseness in relation to the sample weights of the DIN EN method, at least ten times the amount of unwanted and unground material must be weighed out.</p> <p>Note: Misidentification is possible with certain mineral components that lose mass when heated.</p>
<p><b>Adsorption capacity</b></p> <p>[mmol/Z/Liter]</p>	<p>ÖNORM L 1086-1 Chemical analyses of soils - Extraction of the effective exchangeable cations by barium chloride solution and determination of the exchange capacity</p>	<p>The determination of the exchangeable cations (Ca, Mg, K, Na) should be avoided in this case and instead be determined by return exchange, the amount of adsorbed Ba-ions that correspond to the exchange capacity.</p> <p>Conversion of mmol / Z / 100 g in mmol / Z / liter with the bulk density in the dry and compacted state.</p>

(Table 27 continued)

Property Reference value	Description of method	Comments/notes
<b>Nutrients</b>	DIN EN 13651	For determination of the nutrients according to DIN EN 13651, there are currently no reference values, so that no requirements can be given
<b>Nitrogen</b> <b>N</b>  [mg/Liter]	VDLUFA A 6.1.3.1 Determining the soluble mineral nitrogen (nitrate and ammonium nitrate through combined distillation)  VDULFA A 13.1.1 Determining the main and trace nutrients in culture substrates in Calcium chloride DTPA extract (CAT method)	Sample amounts see pH value (footnote 1)
<b>Phosphorus</b> <b>P<sub>2</sub>O<sub>5</sub></b>  [mg/Liter]	VDLUFA A 6.2.1.1 Determining the phosphorus and potassium in Calcium–acetate–lactate (CAL) extract  VDULFA A 13.1.1 Determining the main and trace nutrients in culture substrates in Calcium chloride DTPA extract (CAT method)	Sample amounts see pH value (footnote 1)
<b>Potassium</b> <b>K<sub>2</sub>O</b>  [mg/Liter]	VDLUFA A 6.2.1.1 Determining the phosphorus and potassium in Calcium–acetate–lactate (CAL) extract  VDULFA A 13.1.1 Determining the main and trace nutrients in culture substrates in Calcium chloride DTPA extract (CAT method)	Sample amounts see pH value (footnote 1)
<b>Magnesium</b> <b>Mg</b>  [mg/Liter]	VDLUFA A 6.2.4.1 Determining the plant-available Magnesium in Calcium–acetate–lactate (CAL) extract  VDLUFA A 13.1.1 Determining the main and trace nutrients in culture substrates in Calcium chloride DTPA extract (CAT method)	Sample amounts see pH value (footnote 1)

(Table 27 continued)

Property Reference value	Description of method	Comments/notes
<b>Germinating plant test</b>	VDLUFA A 10.2.1 Detection of non-volatile plant-damaging substances	
<b>Jar test</b>	VDLUFA A 10.2.2 Detection of gaseous plant-damaging substances	The determination is to be carried out when suspected in addition to the germination test.
<b>Foreign materials</b>  <b>Foreign material content</b>  <b>Total area</b>	Method Book of the Federal Quality Association Compost, Chapter II, C 1: Determination of foreign material content  Chapter II, C 3: Total area of foreign substances	
<b>Runoff coefficient <math>C_s</math>/ Runoff reference value <math>C</math>/ discharge coefficient <math>C</math> (Peak discharge coefficient)</b>  (see attachment B.4 to appendix B)	Determination of the runoff coefficient / runoff reference value by determining the water runoff in a block rainfall of $r(15) = 300 \text{ l} / (\text{s} \times \text{ha})$ following a preliminary saturating irrigation	The runoff coefficient / runoff reference value is the quotient of the discharge volume and the rainfall during the block rainfall. As a rule, the determination takes place in the un-greened state of a construction method. Determinations in a greened state are to be marked separately.
<b>Annual water retention</b>  [%]  (see attachment B.5 to appendix B)	Determination of the annual Water retention by registering the amount of precipitation and water discharge	Annual water retention is the difference between precipitation and water discharge expressed in% based on the amount of precipitation.

## **Attachment to Appendix B: Test specifications**

The determination methods for mineral-rich substrates and mineral bulk materials for vegetation strata and drainage layers for green roofs in ready-to-install condition with particle sizes usually up to  $d = 16$  mm and in individual cases up to  $d = 32$  mm are as follows: B.1 Determination of the bulk density (volume weight), B.2 Determination of the maximum water capacity and B.3 Determination of the water permeability.

### **Attachment B.1: Determination of the bulk density**

#### **B.1.1 Principle**

Standardized compaction of 2100-2500 ml loose volume of fresh/moist materials in defined cylindrical vessels. Calculate the bulk density from the volume of the compacted sample and the bulk density wet, the bulk density at maximum water capacity and the bulk density dry after drying at 105 °C.

#### **B.1.2 Apparatus**

- cylindrical plastic containers, inside diameter 150 mm, height 165 mm, with a perforated base:

Radius interval	15°
Perforation perimeter spacing	10 mm
Perforation diameter	5 mm

Number of perforations:

center	1 x 1 = 1
90° intervals	4 x 7 = 28
30°/60° intervals	8 x 6 = 48
15°/45°/75° intervals	<u>12 x 4 = 48</u>
	125

- Sieve, 0.6 mm mesh, diameter 148 mm
- Steel plate, 7 mm, diameter 148 mm (Proctor test DIN 18127)
- Proctor hammer, 4.5 kg drop weight, 450 mm drop height (Proctor test DIN 18127)
- Dry plastic dishes, heat-resistant to 150° C, with a diameter of app. 30 cm
- Drying cabinet
- Scales, tolerance 0.1 g

### B.1.3 Execution

Set a fresh/moist state of 10 - 15% by weight of water content according to visual/manual assessment, determine the water content and indicate it as the test water content for identification. If water is added, the sample must be left standing for at least 3 hours under exclusion of air to allow the water to distribute evenly. Determine the weight of the cylindrical vessel with inserted mesh. Place the substance to be examined in the fresh/moist state in a layer of 120 to 140 mm in height in the cylindrical vessel whose whole base is covered with the mesh.

The filling level is based on the sample height to be achieved in the compacted state of approx. 100 mm. Compacted the material filled over the inserted steel plate with 6 strokes of the Proctor hammer. Determine the sample height in the compressed state by quadruple cross-over measurement from the upper cylinder edge to the sample surface and subtracting from the cylinder inner height and calculate the sample volume at  $\pi \times r^2 \times h$ . Determine the weight of the vessel with sample and calculate the sample weight by subtracting the vessel weight with inserted mesh.

Determine the bulk density at maximum water capacity after determining the maximum water capacity (see appendix B.3). Check the sample height to take into account any swelling. Determine the sample volume and sample weight as described above. To determine the bulk density in the dry state, place the sample, after determining the bulk density at maximum water capacity and determining the water permeability, in dry dishes of known weight and dry at 105°C. Determine the weight of the bowl with the sample and calculate the weight of the dry sample by subtracting the weight of the bowl.

### B.1.4 Calculation

Calculate bulk density under moist conditions ( $\rho_f$ ) using:

$$\rho_f = \frac{m_f}{V} \text{ [g/cm}^3\text{]}$$

$m_f$  = mass (weight) in moist condition in g

$V$  = volume in compacted condition in  $\text{cm}^3$

Calculate bulk density at maximum water capacity ( $\rho_{wk}$ ) using the formula:

$$\rho_{wk} = \frac{m_{wk}}{V \text{ oder } V_{wk}} \text{ [g/cm}^3\text{]}$$

$m_{wk}$  = mass (weight) at maximum water capacity in g

$V_{wk}$  = corrected volume with swelling

Calculate bulk density dry ( $\rho_t$ ) using the formula:

$$\rho_t = \frac{m_t}{V} \text{ [g/cm}^3\text{]}$$

$m_t$  = mass (weight) in dry condition

The determination shall be carried out with 3 parallels in the given sequence on the same samples and the result should be given as a mean value.

## **Attachment B.2: Determining the maximum water capacity**

### **B.2.1 Principle**

The amount of water taken up by compacted materials inside cylindrical vessels (see attachment B.2) after total immersion in water for 24 hours which is then left to drip for a 2-hour period.

### **B.2.2 Apparatus**

see attachment B.2

- plastic bowls with a depth of at least 200 mm for immersion
- spacers, roughly 10 mm deep, to allow water access through a perforated base
- 148 mm diameter filter geotextile fleece to cover the top of the sample
- Sieve, 0.6 mm mesh, diameter 148 mm to cover the top of the sample
- 100 x 100 mm stone sett as a weight to rest on top of the sample
- plastic bowls to allow the water to drip away, with drainage panels on top of them, made from spherical pieces of bonded foam and measuring at least 50 mm thick.

### **B.2.3 Execution**

Cover the surface of the substances compressed in cylindrical vessels (see attachment B 1.3) with the geotextile filter fleece and mesh and weigh them down with stones to prevent them from floating. Place containers in plastic tubs and slowly add water to approx. 10 mm below sample surface. After the surface of the sample has been soaked, continue to fill up to a height of 10 mm above the sample surface. If necessary, top up with water so that the excess water level is maintained. After soaking for 24 hours, remove cylinders, place on drainage panels over plastic bowls and drain for 2 hours. Then dry the containers, remove the cover from the sample surface and determine the weight of the container with the sample. Calculate the weight of the sample by subtracting the known cylinder weight (see appendix B 1.3). Check the volume of the sample (see appendix B 1.3). After determining the water permeability (see appendix B 3), dry the sample at 105° C, as described in appendix B 1.3, and determine its weight.

The water content in g/cm<sup>3</sup> of the compacted sample results from the difference of the mass (the weight) at maximum water capacity and the mass (the weight) in the dry state.

### **B.2.4 Calculation**

Calculate maximum water capacity ( $WK_{\max}$ ) using the following formula:

$$WK_{\max} = \frac{(m_{\text{wk}} - m_t) \times 100}{V \text{ oder } V_{\text{wk}}} \text{ [vol. \%]}$$

$m_{\text{wk}}$  = mass (weight) at maximum water capacity in g

$m_t$  = mass (weight) in dry condition in g

The result is to be expressed as the mean from the 3 parallel tests.

## **Attachment B.3: Determining the water permeability**

### **B.3.1 Principle**

The water permeability is determined by the water infiltration rate/coefficient of absorption (mod.  $K_f$ ). The water absorption coefficient (mod.  $K_f$ ) of the materials in the compressed state is determined in cylindrical vessels (see appendix B 1) and in the state of maximum water capacity via a sinking water level in the unit of time.

### **B.3.2 Apparatus**

see attachments B 1.2 and B 2.2

- Measuring probe rings: wire ring, diameter approximately 40 mm, on which two measuring tips are mounted perpendicular to its plane, 45 mm and 35 mm long.

### **B.3.3 Execution**

After determining the maximum water capacity, cover the sample surface with mesh, place the measuring probe ring on the top and carefully fill the cylinder with water from above, submersing by approx. 10 - 20 mm. Add water continuously as the water level drops so that the submersion is maintained. The actual measurement will start as soon as water flows evenly out of the holes in the base. Fill water up to over the measuring probe. Measure the drop in water level and time for the water level to drop from the top to the bottom measuring probe i.e. from 45 mm to 35 mm.

Determination can be carried out in 3 parallel tests, as described in section 2 above; the measurement is to be repeated 3 times in each case.

### **B.3.4 Calculation**

The water permeability (mod.  $K_f$ ) is calculated as follows:

$$\text{mod. } K_f = \frac{1}{t} \times \frac{h}{h + 4,0} \text{ [cm/s]}$$

h = Height of the compacted sample in cm (see attachment B 1.3)

t = Time for the sinking of the water level from 45 mm to 35 mm in s

The result should be given as the mean value of all measurements and converted into mm/min.

## **Attachment B.4: Determining the runoff coefficient $C_s$ / runoff reference value $C$ / discharge coefficient $C$ (peak discharge)**

### **B.4.1 Principle**

Determination of the runoff coefficient  $C_s$  / the runoff reference value  $C$  / the coefficient of discharge  $C$  - referred to as  $C_s$  in the following - by determining the water discharge from the layer structure of a green roof with 2% dewatering fall in a 15 minute block rain of  $r_{(15)} = 300 \text{ l / (s x ha)} \triangleq 27 \text{ l / m}^2$  after preceding soaking irrigation and draining for 24 hours.

### **B.4.2 Apparatus**

- wind and rain protected testing hall to mount the test equipment
- Measuring tables of 5 m length and 1 m width, with side upstand according to the construction thickness of the roof greening method to be examined, sieve grid of approx. 3 mm mesh width at the end of the drain, adjustable gradient in steps, water-impermeable seal, gutter or drainage funnel at the end of the slope with drainage nozzle;
- Irrigation device consisting of a nozzle tube with as uniform as possible distribution of the block rain, attachment about 60 - 80 cm above the layer structure to be examined, all-sided film protection to avoid drift drip, optionally pressure reducer in the supply line for fine regulation of rainfall, flow meter or precision water meter for detecting the rainfall as a function of time via stopwatch or electronically;
- measuring device to measure the runoff water volume per time unit:
  - visually
    - via collecting receptacle with water exchange indicator, or
    - via a calibrated collecting receptacle, or
    - via a precision water meterand monitoring of time by means of a stopwatch
  - electronically
    - by means of weighing, or
    - via a precision water meterand monitoring of volume and time by means of a data logger

### B.4.3 Execution

The runoff reference value/coefficient of discharge is examined in an un-greened state, unless it concerns construction methods that can only be produced in advance.

Set a gradient of 2 % on the testing equipment. Install the green roofing course construction to be tested in damp condition.

Set up a saturating irrigation until a steady drain of water is maintained for 10 minutes. Check that there is no irrigation drift. Allow to drain for a period of 24 hours so that the state of maximum water capacity is approximately set. Application of the block rain of 27 l/m<sup>2</sup> in 15 minutes in as even an intensity as possible. Record the water discharge during the irrigation period as a function of the time elapse.

The measurement is to be repeated 3 times in 24-hour intervals.

### B.4.4 Calculation

Calculate the runoff coefficient/runoff reference value using the following formula:

$$C_s = \frac{\text{Water discharge in liter in 15 minutes}}{\text{Rain volume in liter in 15 minutes}}$$

The vegetation and rooting have a discharge delaying effect, so that for this 0.05 units are credited and subtracted from the measurement result. For construction methods that can only be produced in advance, e.g. vegetation mats, the additional credit is dropped.

The result is valid up to 5° roof pitch.

For steeper roof pitches, measurements should be made at 5°, 10° and 15° to allow interpolation. For roof pitches greater than 15°, individual tests may be necessary.

## **Attachment B.5: Determining the annual water retention**

### **B.5.1 Principle**

Determination of annual water retention by determining the water drainage on the layer structure of a green roof construction at 2% drainage gradient.

### **B.5.2 Apparatus**

- An area of open space unaffected by shadow to place the testing facilities
  - Weather station to measure the amount of precipitation and other necessary weather data
  - Plot of min. 2 x 2 m = 4 m<sup>2</sup>, with an upstand and a separator matching the thickness of the construction layer under examination. A waterproof covering, water drainage at the lowest end of the facilities with a connecting piece.
  - measuring instruments to measure the runoff water
    - visually
      - via drainage container with approx. 100 L volume and markings
      - via accurate water measuring gauges
      - via flow meter;
    - electronically
      - via float and sensor
      - via accurate water measuring gauges
      - via tipping scales
      - via flow meter
- and monitoring the volume by means of a data logger
- measuring device to measure precipitation and other necessary data, when there is no weather station in the vicinity

### **B.5.3 Execution**

The layer structure to be examined is to be arranged on the measuring table in triplicate. Measurements should be taken over a period of 4 years to obtain a representative average. According to the question, the water discharge can be recorded visually daily at the same time or electronically at time intervals, of e.g. one minute, for further evaluation. Depending on the measuring method used, it may be necessary to interrupt the determination of water discharge during periods of frost. This must be taken into account when evaluating the precipitation measurements.

#### **B.5.4 Calculation**

The annual percentage of water retention in relation to precipitation is calculated as precipitation minus drainage = water retention in liter

$$\frac{\text{Water retention in liter} \times 100}{\text{Rainfall in liter}}$$

The result is taken from the average of three repeated experiments.

For further evaluation, the calculation can be done for varying weather periods.

---

## **Appendix C: Procedure for investigating the root penetration resistance of membranes and coatings for green roofs<sup>1</sup>**

---

1999 Edition, with editorial changes 2002, 2008 as well as

Supplement to "Requirements for transcription/renewal of test certificates"  
(Approved and adopted by the FLL Presidency at the end of 2016, see section 9)

### **Introduction**

In order to exclude vegetation-related structural damage caused by green roofs, in 1984 a working group of the Landscape Development and Landscaping Research Society (FLL) developed a "method for investigating the root penetration resistance of root barrier membranes", which is based on the strain exerted by plant roots on the membranes. The method is essentially based on experience and findings of several years of experiments with different waterproofing membranes and various plant species, which were carried out at the Institut für Bodenkunde und Pflanzenernährung, FH Weihenstephan, [Institute of Soil Science and Plant Nutrition], from 1975 to 1980.

The FLL procedure was revised in 1992, 1995 and for the last time in 1999. Editorial changes were made in 2008. In 2016, adjustments were required based on new requirements of FLL for the transcription and renewal of test certificates (see 9).

It has a high status among manufacturers, planners and contractors, which can be documented by, among other things, the large number of completed and ongoing investigations.

In 1993, the FLL decided to re-examine the previous procedure with a test period of 4 years, with the aim of reducing the test duration to 2 years, without weakening the intended strict standards of the previous test.

After experiments at the Institut für Bodenkunde und Pflanzenernährung, FH Weihenstephan, these specifications were finally agreed: The 2-year test takes place in a climate-controlled greenhouse, the plant species used at corresponding temperature and light conditions grow throughout the year. Thus, an effective growth period of 24 months is achieved, which is of similar duration to the 4-year test, taking into account the annual multi-month dormancy period of the vegetation under field conditions. Both tests are considered equivalent and are described together in the present reformulation of the procedure.

In the course of changes in content, a formal redesign was also carried out to make the process easier to understand and to make it easier for the testing institutions to evaluate the results obtained.

---

<sup>1</sup> Arbeitskreis „Dachbegrünung“ der FLL, Arbeitsgruppe „Durchwurzelungsschutz“: Prof. Dr. P. Fischer, Freising-Weihenstephan (Leitung); Dipl.-Ing. R. Bohlen, Ladbergen; R. Klein, Wächtersbach-Neudorf; Prof. Dr. H.-J. Liesecke, Hannover; Prof. Dipl.-Ing. G. Lösken, Hannover; Dipl.-Ing. P. Siegert, Tornesch; Dipl.-Ing. W. Tebart, München; Dipl.-Ing. R. Walter, Stuttgart

## 1 Area of validity

This procedure covers investigations into resistance to root penetration of roots and rhizomes of different test plants for

- root barrier membranes
- roof and waterproofing membranes, and
- liquid surface treatments

for all types of green roofing (intensive greening, simple intensive greening and extensive greening).

This procedure includes testing of products including all jointing techniques linked to them. Therefore, it is admissible only for testing purposes related to individual membranes and/or surface coatings. The investigation of a roofing system, i.e. composite construction of several layers for the roof waterproofing is not possible.

For technical reasons, it may be necessary to install a separate layer under the coating for coatings in the liquid application. This is permitted, provided that the manufacturer clearly states that the root resistance is effected solely by the top layer coating. A

Any lamination, i.e. a separate layer on top of a membrane and/or coating to be tested is to be excluded.

The result of the tested membrane or coating is not transferable to the ingress and penetration resistance of plants with strong rhizome growth (e.g. bamboo and Zebra grass). If such plant species are used, structural precautions beyond the proven ingress and penetration protection must be taken and special care measures provided.

This procedure does not extend to investigations into environmental compatibility of any product tested.

The European Standard DIN EN 13948 "Flexible sheets for waterproofing - Bitumen, plastic and rubber sheets for roof waterproofing - Determination of resistance to root penetration" emerged from the FLL method for investigating the root resistance of membranes and coatings for green roofs.

Although both procedures have almost identical contents there are some important differences:

- The FLL procedure tests 8 instead of 6 trial containers for each product tested and is therefore more comprehensive.
- The FLL procedure takes rhizome forming couch grass as a second testing plant besides pyracantha, while the DIN EN 13948 uses only one test plant, pyracantha. This means that products fitting the DIN EN 13948 can only be certified as root resistant and not rhizome resistant as per FLL.

The FLL procedure includes all relevant elements of the European standard DIN EN 13948, goes beyond their requirements and is therefore considered to be of higher quality in the professional world. Therefore, from a technical point of view, a root barrier membrane tested according to the FLL method can also be designated as root-resistant according to DIN EN 13948.

## **2 Definitions**

For the application of this procedure, the following definitions shall be applied:

### **2.1 Trial containers**

Containers, with minimal dimensions, which have been specially equipped for the examination. The containers are equipped with the membrane or coating to be tested (trial containers) and with a geotextile fabric (control container).

### **2.2 Moisture course**

The moisture layer consists of coarse-grained mineral material which is arranged below the membrane or coating to be tested. It is kept moist all the time and thus enables the further growth of roots and rhizomes that have penetrated through the membrane or coating to the transparent bottom of the vessel and thus allow the early detection of penetrations.

### **2.3 Protective ply**

With the membrane or coating-compatible geotextile, which is placed directly under the material to be tested on the moisture layer to achieve a uniform pressure distribution.

### **2.4 Vegetation stratum**

Standard cultivation substrate (materials mixture) readily available, or which can be made up, in a consistent form at any investigation site. The structure of this layer shall be stable, offer good water and air management properties and be lightly fertilized. These conditions favor an optimum root development of the test plants. The vegetation stratum is in direct contact with the membrane to be tested.

### **2.5 Test plant species**

#### **2.5.1 For the 2-year test**

- *Pyracantha coccinea* 'Orange Charmer', ornamental shrub which under greenhouse conditions shows an all year round root growth suitable for the test, and
- *Agropyron repens*, couch grass, an indigenous grass with slow growing rhizomes which settle readily on green roofs and which also grows sufficiently all year through under the given testing conditions

#### **2.5.2 For the 4-year test**

- *Alnus incana*, grey alder, a wild woody plant which shows root growth suitable for the test under the given outdoor conditions during the vegetation period, and
- *Agropyron repens*, couch grass.

## 2.6 Sufficient growth performance of the test plants

The woody plants (pyracantha and alder) in the trial containers have to show an average growth performance of at least 80 % (height, diameter of the stem) of the plants in the control containers during the entire duration of the investigation. This enables any harmful effect to the test plants, which may have been caused by substances emitted by the test materials, to be detected.

The spreading of the couch grass on the substrate surface will be evaluated visually (see 2.7). In this case, the plants in the test vessels from the first interim evaluation (see 7.1) must have on average at least one average population density during the entire test period (see 2.7).

## 2.7 Evaluating of the couch grass growth

For the visual evaluation of the population density of the couch grass, the following figures are assigned. The classification is as follows:

- 1 = hardly any couch grass present (about 0 – 20 % of the surface covered)
- 2 = thin growth (about 20 – 40 % of the surface covered)
- 3 = medium growth (about 40 – 60 % of the surface covered)
- 4 = dense growth (about 60 – 80 % of the surface covered)
- 5 = very dense couch grass growth (about 80 – 100 % of the surface covered)

## 2.8 Equivalent joining techniques

In the investigation, it is admissible to combine different joining techniques as far as they aim exclusively at producing material-homogenous seamed joints (e.g. solvent bonding – with a solvent which evaporates – and hot gas welding). Such types of seam bonding are considered to be equivalent.

In contrast to this, combinations of bonding-free joints and joints with bonding glue or joints using two different types of glues are not considered to be equivalent.

## 2.9 Root ingress

Any root which has established itself in the surface or in the seams of a tested membrane and/or surface coating (root ingress), where subterranean plant parts have actively created cavities and have thus damaged the membrane and/or coating.

Not to be evaluated as root ingress but to be noted in the test documentation are:

- roots which have already grown into the pores of the membrane or coating (surface or seam and/or work interruption seam, i.e. no damage). In order to ensure a clear evaluation, the membrane or coating section in question needs to be inspected with a microscope
- roots which have grown into the surface of or seam and/or work interruption seam of the membrane or coating  $\leq 5$  mm which contains radicide substances (root retardant agents), since any root retarding effect can only act upon penetration of the root into the membrane/coating. In order to ensure a clear evaluation, such membranes/coatings have to be clearly marked as “radicide-containing” by the manufacturer before the investigation is carried out

- roots which have grown into the surface of products which are composed of several layers (e.g. bituminous sheeting with copper band inlays or elastomer membranes with inlays or reinforcements) if the layer taking over the function of a penetration barrier has not been damaged. In order to ensure a clear evaluation, this layer has to be clearly defined by the manufacturer before the investigation is carried out
- roots which have penetrated seam sealing (without damaging the seam)

## 2.10 Root penetration

Roots which have penetrated the area or the seams of the tested membrane and/or coating. These roots have used pores present in the membrane or coating or have actively created cavities.

## 2.11 Certificate “root resistant”

A membrane and/or coating is considered to be “root resistant” if, upon termination of the test phase, no root ingress according to section 2.9 and no root penetration according to section 2.10 was found in any of the containers. Furthermore, one of the preconditions is that all woody plants used in the investigation have shown sufficient growth performance according to section 2.6 throughout the entire test phase.

## 2.12 Couch grass rhizomes

Since the evaluation differentiates between roots and rhizomes a reliable determination of these subterranean plant organs is indispensable.

The following indications serve as a basis for the evaluation:

- the couch grass rhizomes (subterranean shoots) spread through the vegetation stratum and show a regular thickness of ca. 2 mm and minimal branching. They are divided into individual sections with knots forming the boundaries between the sections. Around the knots inconspicuous small leaves surrounding the stem as well as thin roots have formed. In between the knots the couch grass rhizomes are hollow (see Fig. 1)
- in contrast, roots of the pyracantha vary in thickness and show vigorous branching. Leaves never form, and they are not hollow.

If the testing institute has difficulties to clearly differentiate between rhizomes and roots, expert consultation is required.



**Fig. 1:** Schematic representation of the couch grass rhizome (left) with knots (1), roots (2) and leaves (3) as opposed to a pyracantha root (right)

### **2.13 Evaluation of couch grass rhizomes**

Couch grass rhizome penetration into the membrane and/or coating (surface or seams) is detected and noted in the test report, but not evaluated in regard to resistance to root penetration. If no damage of the product due to rhizomes is found, an explicit statement stressing this fact is to be included into the test report (see 2.14).

### **2.14 Certificate “rhizome resistant against couch grass”**

A membrane and/or coating is considered to be “rhizome-resistant against couch grass” if, upon termination of the test phase, - parallel to root ingress (see 2.9) and root penetration (see 2.10) - no rhizome ingress nor rhizome penetration is found in any container.

This assumes that all couch grasses used in the investigation have shown sufficient growth performance throughout the entire test phase (see 2.6).

### **2.15 Incidents leading to a premature termination of test**

If during the test phase, visible penetrations of roots or rhizomes into the membrane and/or coating to be tested are identified (see 7.1), the client who has commissioned the investigation needs to be informed. The test is stopped if the penetrations are caused by roots. If any rhizomes have penetrated the test material, the investigation may be continued upon mutual agreement with the client.

Should more than 25 % of the woody plants die off during the test phase, the investigation has to be started anew, i.e. new planting needs to be carried out. At the same time, the vegetation stratum needs to be replaced. A new date has to be assigned to the beginning of the test phase.

The same procedure shall be applied if during the test phase no sufficient root growth of the test plants can be achieved (see 2.6).

## **3 Brief description of the procedure**

The resistance to root penetration of root barrier membranes as well as roof and waterproofing membranes and/or surface coating is tested against roots and rhizomes of test plant species in a trial container and under standardized conditions.

During a 4-year test, the examination is carried out outdoors. Alders and couch grasses are used as test plants. The 2-year test is carried out in a climate-controlled greenhouse using pyracantha and couch grass.

The membrane and/or coating, which needs to show several seams/joints and/or one work interruption joint, is installed in 8 trial containers. 3 more containers without any membranes or coatings are included into the test. They serve as a control for plant growth.

A thin vegetation stratum is laid into the containers. With dense planting, moderate fertilizing and modest watering the desired high root pressure shall be obtained.

At the end of the investigation, the vegetation stratum is removed and an examination of the membrane and/or coating is effected, focusing on the detection of any root and/or rhizome ingress or penetration.

Control samples of any membrane and/or coating tested are stored at the test institute.

## **4 Test facilities and material**

### **4.1 Location of the testing**

#### **4.1.1 For the 4-year investigation**

A hall is to be used equipped with a transparent roofing, otherwise open on all sides.

This creates conditions similar to outdoor conditions. At the same time any precipitation, which might lead to water logging in the non-draining containers, is held off.

An unheated greenhouse is also permissible as long as it has sufficient ventilation and allows a frost effect.

#### **4.1.2 For the 2-year investigation**

Provide a greenhouse with adjustable heating and ventilation. The heating should be set so that the inside temperature is 18 ( $\pm 3$ ) °C during the day and 16 ( $\pm 3$ ) °C during the night. At an internal temperature of 22 ( $\pm 3$ ) °C the greenhouse must be ventilated. A persistent internal temperature > 35 °C should be avoided.

The natural light conditions in Central Europe ensure favorable growth of the test plants throughout the annual cycle at the indicated temperatures. A shading of the plants in summer or an artificial exposure in winter are not required.

The space demand per container (800 x 800 mm), respecting the required minimum distance according to section 6.1, amounts to approx. 1.5 to 2 m<sup>2</sup>, depending on the arrangement of the containers.

### **4.2 Trial containers**

The internal dimensions of the containers used in the trial shall not be less than 800 x 800 x 250 mm, but larger containers may be needed if the circumstances under which they are to be installed so require.

Trial containers are to be fitted with transparent bases (e.g. acrylic glass) so that root penetration can be detected even during the test phase without interfering with the vegetation stratum. The base of the container shall be darkened (e.g. by means of a foil which is impervious to light), in order to avoid the growth of algae in the moisture layer. Ideally, the transparent container base will be a tray with a 20 mm upstand to maintain a constant supply of water in the moisture course. The water supply into the moisture layer is affected by means of a filling pipe. This pipe shall have a diameter of 35 mm and is mounted on the outside of the container, pointing upwards and abutting onto the upstand of the base tray (see Fig. 2).

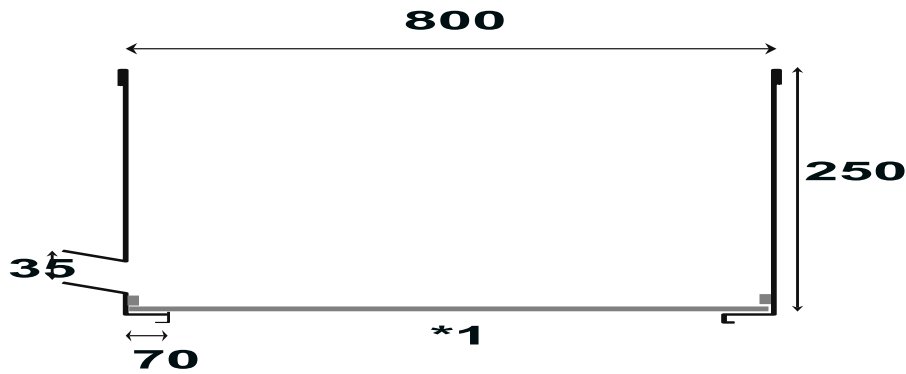

**Fig. 2: Construction design of the trial containers (minimum dimensions, all figures in mm, \*1 = transparent base with upstand)**

For each membrane and/or coating to be tested, 8 trial containers are required. In addition, per experimental run – regardless of the number of sheets/coating to be tested – 3 control containers (without any membranes/coating) must be provided.

#### 4.3 Moisture layer

This layer consists of expanded slate or expanded clay (particle size 8 – 16 mm) which has to meet the quality requirements indicated in Tab. 1. In order to avoid any in-house analysis necessity, it is useful to only use products which are subjected to permanent quality controls in regard to the described guidelines. Thus, the manufacturer will guarantee the required properties.

For the required course depth of 50 (± 5) mm (see 6.1) the material requirement amounts to 32 l per trial container (800 x 800 mm).

#### 4.4 Protective geotextile fleece

A geotextile fleece made from synthetic fibers with a weight of approx. 200 g/m<sup>2</sup> is to be used. The material compatibility of the geotextile fleece fabric with the membrane/coating to be tested, needs to be ensured. The material requirement amounts to 0.64 m<sup>2</sup> per trial container (800 x 800 mm).

#### 4.5 Membrane and/or coating to be tested

The membrane/coating has to be laid and/or applied according to paragraph 6.1. The surface to be treated (minus the 50 mm depth of the moisture course) amounts to a calculated figure of about 1.3 m<sup>2</sup> (without overlapping) per container with the minimum dimensions (800 x 800 x 250 mm).

#### 4.6 Growing media

The media consists of:

- 70 vol. % minimally decomposed North German moorland peat and
- 30 vol. % expanded clay or slate (particle size 8 – 16 mm) of the quality indicated in Tab. 17. As described in paragraph 4.3, it is useful to only use products which have undergone quality testing.

Add calcium carbonate (CaCl<sub>2</sub>) to bring the pH value to figures between 5.5 and 6.5 (see 4.7).

The initial fertilizing defined in paragraph 4.8 is mixed with the vegetation stratum in a homogenous way before filling the container.

In a 4-year investigation, the substrate requirement amounts to about 96 l per trial container (800 x 800 mm) with a required layer depth of 150 (± 10) mm, for the 2-year investigation to about 88 l per container (taking into account a substrate supply via plant root balls).

**Tab. 1: Required quality of expanded clay/slate. Determination with water extracted from the ground material with demineralized water in a 1:10 (weight/vol.) ratio**

Soluble salts (calculated as KCl)	< 0,25 g/100 g
CaO	< 120 mg/100 g
Na <sub>2</sub> O	< 15 mg/100 g
Mg	< 15 mg/100 g
Cl <sup>-</sup>	< 10 mg/100 g
F <sup>-</sup>	< 1.2 mg/100 g

#### 4.7 pH settings

For the vegetation stratum, different quantities of calcium carbonate may be necessary in order to set the desired pH value to 5.5 – 6.5.

The required quantity can be determined by using the following procedure:

- take 5 samples of 1 l each from the well mixed vegetation support course
- moisten the samples with tap water
- mix the samples with different quantities (4, 5, 6, 7 or 8 g) of calcium carbonate
- put the samples into a plastic bag; close and label them
- store the samples in the bag for about 3 days at room temperature
- send the samples to a laboratory which works to the regulations of the VDLUFA association methods and request a pH analysis in CaCl<sub>2</sub>
- extrapolate the quantity of calcium carbonate which has led to the desired pH value in the 1 l sample to the entire volume of the vegetation support course

#### 4.8 Fertilizer

For an initial fertilizing, a multiple-nutrient fertilizer with approx. 15 % N, 10 % P<sub>2</sub>O<sub>5</sub>, 15 % K<sub>2</sub>O, 2 % MgO and less than 0.5 % Cl as well as a fertilizer containing nutrient trace elements with Fe, Cu, Mo, Mn, B and Zn is to be used. Per container (800 x 800 mm), 30 g of a multiple-nutrient fertilizer are to be applied. The fertilizer containing nutrient trace elements is used in the quantity recommended for substrates by the manufacturer.

Use slow release fertilizer capsules with approx. 15 % N, 10 % P<sub>2</sub>O<sub>5</sub>, 15 % K<sub>2</sub>O and a release time of 6 – 8 months for the repeat fertilizing. The requirement on fertilizers amounts to 30 g/container (800 x 800 mm) each time.

#### 4.9 Tensiometer

In order to monitor the watering of the vegetation support course, each container needs a tensiometer with a measuring range of 0 – 600 hPa.

#### 4.10 Test plants

For the 4-year investigation the following 2 plant species, meeting the defined quality requirements, shall be used:

- *Alnus incana* – grey alder, 2-year replanted seedling, height 60 – 100 cm, and
- *Agropyron repens* – couch grass, seeds

For the 2-year investigation the following 2 plant species, meeting the defined quality requirements, shall to be used:

- *Pyracantha coccinea* ‘Orange Charmer’ - *pyracantha* – in a 2 liter container, height 60 – 80 cm
- *Agropyron repens* – couch grass, seeds

Each trial container, with dimensions of 800 x 800 mm, is to be planted with 4 woody plants (alder, pyracantha) as well as 2 g of couch grass seeds.

This leads to a calculated plant density of 6.25 woody plants/m<sup>2</sup> and 3.13 g seeds/m<sup>2</sup>. If larger trial containers are used, the plant density has at least to reach the figures indicated above by increasing the number of plants and the quantity of seeds.

When buying the plants, it must be ensured that plant quality does not vary.

#### 4.11 Watering

The water used for watering shall meet the minimum quality requirements listed in Tab. 18. Enquiries must be made as to the local water quality at the waterworks responsible for the supply of the facility. If any of the values laid down in Tab. 18 are exceeded, the water for watering needs to be blended with fully desalinated water or with rain water.

**Tab. 2: Minimum quality requirements for water used for watering**

Conductivity	< 1000 µS/cm
Sum earth alkaline	< 5.4 mmol/l
Acid capacity (up to pH 4,3)	< 7.2 mmol/l
Chloride	< 150 mg Cl/l
Sodium	< 150 mg Na/l
Nitrate	≤ 50 mg NO <sub>3</sub> /l

### 5 Samples and information provided by the manufacturer

Samples from the membrane/coating under investigation are to be taken by the test institute for retention before and after the investigation. The material taken as a sample has to include at least one bonding seam per jointing technique and/or one work interruption joint and shall have a size of at least 0.5 m<sup>2</sup>. Retained samples are to be stored in dark and dry conditions at a temperature above 5 °C and not exceeding 25 °C. The duration of retention has to be equal to or exceed the period of validity of the test report (see 8). Care must be taken during storage to ensure no contact with incompatible materials.

In order to ensure a clear identification of the tested product, the following information needs to be provided by the manufacturer before the test is started: product name, area of application, material description, material standards, thickness (without lamination), finish/structure, form of delivery, manufacturing technique, test certificates, year of manufacture, installation/laying technique at the location of the investigation (overlapping, jointing techniques, jointing agents, type of seam sealing, covering strips over seams, special corner and angle joints), additives of biocides (e.g. root inhibitors) with details regarding the concentration of the substances.

In addition, a product data sheet of the membrane/coating to be tested, has to be handed in for retention at the test institute.

Moreover, for products consisting of several layers (e.g. bituminous sheeting with copper band inlays or PVC or elastomer membranes with inlays/reinforcements) the manufacturer has to define, in an unambiguous way before the start of the investigation, which layer is meant to take over the function of an ingress and penetration barrier.

## **6 Testing conditions**

### **6.1 Preparation and installation of the 8 trial containers**

The trial containers shall be prepared with the following layered structure (from bottom to top): moisture lay, protective ply, membrane and/or coating to be tested, vegetation stratum, planting.

Directly above the transparent base of the container, the bottom layer, the moisture layer is laid with a depth of 50 ( $\pm$  5) mm.

The protective ply is cut to size, based on the base area of the container and laid directly onto the moisture layer. On top of the protective lining the membrane/coating is applied as described in paragraphs 6.1.1 and 6.1.2.

After the installation of the membrane/coating to be tested, the vegetation substrate is filled firmly to a layer depth of 150 ( $\pm$  10) mm. This corresponds to a substrate volume of 96 l (4-year test) and 88 l (2-year test) respectively (see 4.6) for a receptacle of 800 x 800 mm.

Per trial container of 800 x 800 mm and for a 4-year investigation 4 *Alnus incana* plants (grey alder), for a 2-year test 4 *Pyracantha coccinea* shall be planted equally spread over the entire surface (see Fig. 3). Furthermore, for both investigation types and per receptacle 2 g of seeds of *Agropyron repens* (couch grass) are to be equally sown onto the vegetation support layer.

If larger trial containers are necessary, the number of plants and the quantity of seeds needs to be increased so that the minimum plant density is reached (see 4.10).

Place the ceramic cell of the tensiometer into the vegetation stratum directly on top of the membrane/coating. Thus measurements can be carried out in the lowest part of the root area. The tensiometer shall be placed at an equal distance to the plants (see Fig. 3).

It is advisable to place the containers on stands to facilitate root penetration checks at regular intervals. Keep a minimum distance of 0.4 m between and around the containers, which are to be arranged in a random order.

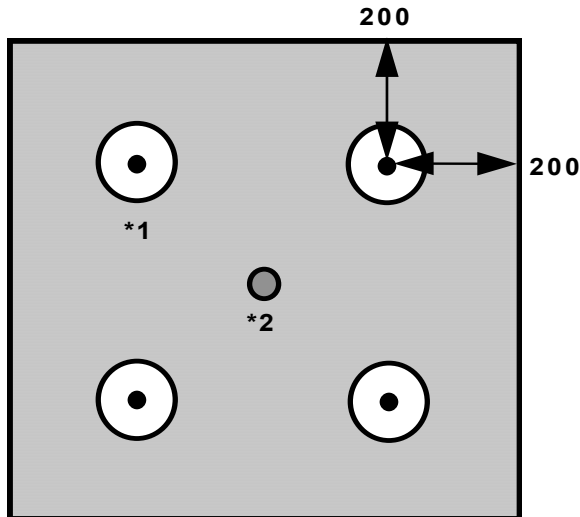

Fig. 3: Arrangement of woody plants (\*1) and tensiometer (\*2) in the vegetation stratum in a 800 x 800 mm container (dimensions in mm)

### 6.1.1 Installation of root barrier membrane, roof and waterproofing membranes

Cut out parts of the membrane/lining to be tested and install them as required into the trial containers. The client who commissions the investigation is responsible for the professional execution of the work at the testing location. Create 4 seams at the corners where the walls meet, 2 seams along the base at the corners and one T-seam running along the middle (see Fig. 4). Hereby it is admissible to use different jointing techniques as long as these are equivalent (see 2.8).

The membrane shall be brought up to the rim of the container walls.

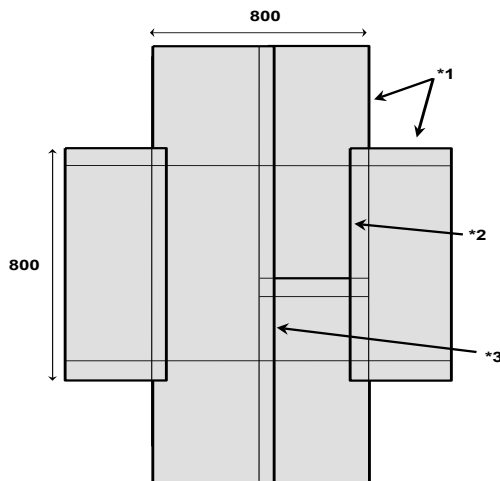

Fig. 4: Layout of the seams (\*1 = wall-corner seam, \*2 = base-corner seam, \*3 = T-seam) in the membrane to be tested (dimensions in mm)

### **6.1.2 Installation of surface coating under investigation – liquid surface treatment**

The liquid surface coating is applied as required at the testing location under the responsibility of the client who commissions the investigation. The coating shall be applied in 2 stages. In the center of the container, there is to be a work interruption joint going all the way through the material under testing. The time interval between both stages of work shall be at least 24 hours.

The coating shall be brought up to the rims of the container walls.

### **6.2 Preparation and installation of the 3 control receptacles**

Preparation and installation of the control receptacles is affected as described in paragraph 6.1. However, no membrane/coating to be tested is installed, i.e. the vegetation stratum is laid immediately on top of the protective ply.

### **6.3 Care of the plants during the growth period**

The substrate moisture content is to be set according to the needs of the plants by means of top watering onto the vegetation support course. The moisture (soil moisture tension) shall be checked by means of a tensiometer.

In order to ensure a good germination of the seeds and/or good root take of the woody plants in the first 8 weeks after the greening process, irrigation is carried out as soon as the soil moisture tension drops below a value of  $-100$  hPa. In the course of the investigation watering is applied only if the soil moisture tension falls below values between  $-300$  and  $-400$  hPa. The irrigation volumes are to be dimensioned for achieving a soil moisture tension in the substrate of nearly  $0$  hPa. Ensure the entire vegetation support course (including peripheral areas) is equally moistened. Avoid any lasting water excess (water logging) in the lower areas of the vegetation support course. In order to avoid damaging the tensiometers, the devices need to be taken out of the containers at the beginning of the first frost season (for the 4-year investigation). Irrigation during the dormant phase of the vegetation shall be adapted to the low water demands of the plants. After the last frosts in spring, the tensiometer devices shall be placed back at the same position. Irrigation is continued as described above.

The moisture layer shall be kept constantly wet by watering via the feed pipe which is mounted to the container.

Any repeat fertilizing for a 2-year investigation shall be carried out in semi-annual intervals with a fertilizing agent and in the quantities listed in paragraph 4.8. The first feed shall be applied 3 months after planting. In the 4-year investigation repeat fertilizing is given once a year in March or April.

Any foreign growth and any plant parts which have died back and fallen onto the surface of the vegetation support course are to be removed.

Any wood plants which have died (pyracantha and/or alder) shall be replaced. In order not to interfere with root growth of the remaining plants replacement planting is admissible only during the first 3 months in the 2-year investigation and during the first 6 months in the 4-year investigation. If during the course of the investigation the losses of woody plants account for more than 25 % of the total plant number the test shall be re-started (see 2.15).

If the pyracantha and/or alder need to be pruned, a growth height of at least  $(150 \pm 10)$  cm shall be kept. Any pruning shall be affected on the same day on plants in both trial and control containers.

In the areas between the containers, side shoots may be pruned if they are an obstacle to using the areas.

Any insufficient couch grass growth (< 40 % of the surface is covered) shall be improved by up to 2 units of repeat seeding in the first 3 months (2-year investigation) or 6 months (4-year investigation) of the test.

To avoid collapse of the couch grass all blades of grass shall be cut back to a height of 5 cm once they have reached a growth height of ca. 20 cm.

In case of strong pest attacks and/or any plant diseases threatening the survival of the plants, testing appropriate plant protection measures shall be carried out.

## **7 Evaluations**

### **7.1 Evaluations during the testing**

In the 2-year investigation as well as in the 4-year investigation the transparent bases of all 8 trial containers shall be examined at intervals of 6 months in order to detect visible roots and rhizomes (i.e. successful root penetration).

If visible root penetration is discovered in the trial containers, the client who commissioned the investigation shall be informed. The trial may be discontinued (see 2.15).

Apart from this notification, no interim results in writing shall be disseminated during the duration of the trial.

In semi-annual intervals (2-year investigation) or annually (4-year investigation) growth performance of the woody plants shall be monitored by measuring the height and diameter of the trunk at a height of 20 cm. The propagation of the couch grass on the substrate surface is also to be evaluated (see 2.7). The average growth performance of the plants in the trial containers shall be determined and compared with the result of the control containers. If no sufficient growth is achieved in accordance with paragraph 2.6, the test shall be re-started (see 2.15).

Any plant damages, e.g. deformations of the leaves or changes in leaf color, shall be noted separately.

### **7.2 Evaluation at the end of the trial**

The client commissioning the investigation shall be notified of the date and time of the planned final evaluation to enable him to personally attend the session.

The evaluation commences with a final monitoring of the growth performance of the plants as described in paragraph 7.1.

At the end of the trial, the vegetation stratum is taken out of all trial containers in order to examine the membrane/coating for root and rhizome ingress and/or penetration. According to paragraphs 2.9, 2.10 and 2.12 roots and/or rhizome ingress and penetration into the membrane/coating shall be recorded in absolute figures.

This examination shall be done separately for the following areas

- for root barrier membranes, roof and waterproofing membranes:
  - the surface and
  - the seams
- or liquid surface coating:
  - the surface and, if possible
  - the work interruption joint, if the latter is visible

If more than 50 roots and/or rhizomes ingresses per container are found in the membrane/coating, the evaluation of these ingresses – as opposed to the above described – shall be performed only on a section of the tested material. In that case, the evaluation has to cover at least 0.2 m<sup>2</sup> (about 20 % of the membrane/coating covered with the substrate) and shall be performed in the area indicated in Fig. 5.

In case of penetration of roots/rhizomes into the overlapping area of seams, the maximum penetration depth shall be recorded.

Photographic evidence shall be provided of some evidence of root ingress or penetration (as an example).

Samples of the membrane/coating for retention purposes shall be taken to mirror the result of the investigation. The samples shall be stored in compliance with the stipulations laid down in paragraph 5.

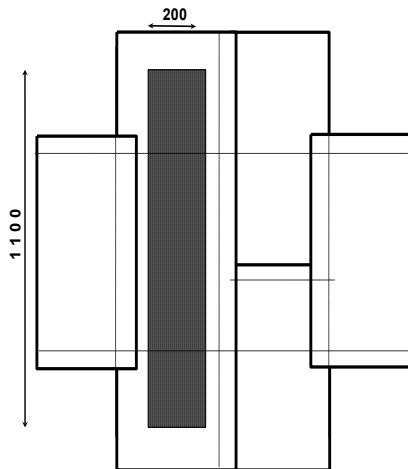

**Fig. 5: Evaluation section of ingress into the surface of a membrane/coating under testing in case of > 50 ingresses/receptacle (dimensions in mm)**

## 8 Test report

No interim results shall be announced during the trial.

Upon termination of the trial, a complete test report about the given test situation shall be written up in two copies (1 copy each for the test institute and the client), but only if the membrane/coating has proven to be “root resistant” in accordance with paragraph 2.11. Companies and products which have participated in the investigation without success shall not receive any test report but only a notification in writing with a statement and related explanations that the membrane/coating has not successfully passed the root resistance test based on FLL standards.

The report may only be used only in a non-abbreviated form and shall contain the following data:

- details provided by the manufacturer in relation to the membrane under testing in accordance with paragraph 5
- detailed information as regards the preparation of the trial containers according to paragraph 6 (or information that trial has been carried out in compliance with the FLL guidelines, the guidelines used for the investigation shall be enclosed as an appendix)
- all evaluation results in accordance with paragraph 7, and
- a summary evaluation of the tested membrane according to paragraphs 2.11 und 2.13

Furthermore, the report shall incorporate the following statements:

- “The test report encompasses ..... pages and may only be used in a non-abbreviated form”
- “The findings of the investigation are bound to all reference data and material properties of the tested membrane listed in the test report in compliance with the requirements, as well as to the jointing techniques which have been used or which are considered to be equivalent”
- “Retention samples of the tested membrane/surface coating will be kept at the test institute”
- “The test report was compiled on (date) ..... and has a general period of validity of 10 years.

## 9 Transcription/renewal of test certificates

The following requirements apply to the transcription or renewal of test certificates:

1. In principle, transcription or renewal of test certificates is only possible if identical membranes are provided; the following changes are also acceptable:

- Slating and sanding;
  - Thicker membrane than the tested membrane.
2. Non-identical and thus non-certifiable membranes are especially following these modifications/changes:

- Change of the trade name/trademark of the product being tested;
- Modification of laminations (e.g. geotextiles, foils, etc.);
- Change of color pigments;
- Changes in production technology, e.g. changes in calendering or extruding;
- Change of talc conversions;
- Differences in the material of the carrier inserts;
- Use of other additives (modified formula);
- Modified additives (e.g. formulation change at Preventol).

3. Laminations or laminated layers

If possible and common in practice, laminated layers must be removed before starting the test; unless an edge area without lamination guarantees a professional joining technique or lamination is an essential part of the root protection of the product.

*(Laminations are, for example, foils that are intended only for transport and easier unrolling of the webs. Thin films which are virtually insoluble and melt when joining on the basis of the joining technique do not have to be removed).*

4. Scope of Certificates

The test reports issued by the respective investigation body certify the test results. The investigation bodies cannot give additional test certificates for the installation in certain situations on the construction site. Reasons are e.g. commonly used fire retardants on site.

5. Renewal of test certificates; intervals

All test certificates first issued for a period of 10 years.

If the membranes are identical, test certificates may be renewed up to a maximum of twice for a period of 5 years each. The certificate does not come with different validity periods (e.g. 10, 15, 20 years ...) but according to the principle: 10 + 5 + 5 years).

## 10 Responsibilities

The client who commissions the investigation is responsible for:

- procurement and installation of the protective ply (see 2.3 and 6.1) and the membrane and/or coating to be tested (see 6.1)
- provision of a material sample (see 5), and
- details in relation to the tested membrane and/or coating (see 5)

The test institute commits itself to providing the following services:

- provision of a suitable space to carry out the investigation (see 4.1)
- taking and storage of a material sample (see 5)
- procurement and/or creation and installation of the moisture layer and the vegetation stratum (see 4.3, 4.6, 6.1 and 6.2)
- procurement and installation of the tensiometer devices (see 4.9, 6.1 and 6.2)
- procurement of the test plants and/or the seeds, as well as for the greening of the containers (see 4.10, 6.1 and 6.2)
- care of the plants during the growth period (see 6.3)
- all evaluation processes (see 7), and
- creating a final test report (see 8)

The trial containers (see 4.2) may be provided by either the client or the test institute. The responsibilities are to be subjected to contractual agreements between the client who commissions the investigation and the test institute. These contractual agreements also regulate the expenses incurred for the investigation, which shall be borne by the client.

This release version is your personal version. The forwarding of this file or individual excerpts to third parties is only permitted with the express consent of FLL!



# Gesamtverzeichnis der Veröffentlichungen

**Forschungsgesellschaft  
Landschaftsentwicklung  
Landschaftsbau e.V.**

**Friedensplatz 4  
53111 Bonn**

**Tel: 0228/96 50 10-0  
Fax: 0228/96 50 10-20**

[info@fll.de](mailto:info@fll.de)  
[www.fll.de](http://www.fll.de)

Die Schriftenreihe der FLL umfasst vielfältige Regelwerke und Veröffentlichungen zur Planung, Herstellung, Entwicklung und Pflege der Landschaft und Freianlagen.

Sie richten sich insbesondere an

- Öffentliche und private Auftraggeber,
- Landschafts-, Hochbau- und Innenarchitekten,
- Produktionsgartenbaubetriebe (Baumschulen, Stauden-, Zierpflanzen- und Saatgutzüchter),
- Landschaftsgärtner und Ausführende von landschaftsgärtnerischen Bau- und Pflegearbeiten,
- Produkthersteller
- Sachverständige für die genannten Bereiche.

## [FLL-Regelwerke](#)

FLL-Regelwerke ergänzen einschlägige DIN - Normen und die Allgemeinen Technischen Vertragsbedingungen (ATV) der Vergabe- und Vertragsordnung für Bauleistungen (VOB), Teil C. Sie enthalten Regelungen zu Anforderungen an Stoffe, Bauteile, Pflanzen und Pflanzenteile sowie für Ausführung und vertragsrechtliche Regelungen bei Landschaftsbau- und Pflegearbeiten. Die Regelungen sind **neutral**, also unabhängig von Produkten oder Systemen. Von der Wissenschaft als theoretisch richtig anerkannt, haben sie sich in der Praxis bewährt. Sie sind damit als **anerkannte Regeln der Technik** zu werten und enthalten wichtige Ausführungen zum **Handelsbrauch** und der **gewerblichen Verkehrssitte**.

Verschiedene Regelwerke werden durch ausdrückliche Aufführung in DIN-Fachnormen Bestandteil von Verträgen (z.B. DIN 18915 ff. Landschaftsbau-Fachnormen, DIN 18035 Sportplatzbau-Fachnorm, etc.). Darüber hinaus werden FLL-Regelwerke zum Bestandteil von VOB-, VOL- und Werkverträgen als anerkannte Regeln der Technik sowie als formulierter Handelsbrauch oder gewerbliche Verkehrssitte. (PDF-Katalog mit ausführlichen Inhaltsangaben zum [Download](#) ca. 4MB)

## [Arbeitsgremien](#)

Für die Bearbeitung der FLL-Regelwerke gelten Grundsätze der DIN-Normungsarbeit: Mitarbeit der betroffenen Kreise, z.B. Auftraggeber, Landschaftsarchitekten, Landschaftsgärtnern, Produzenten von Stoffen, Bauteilen, Pflanzen und Pflanzenteilen, Wissenschaftler; bei Bedarf werden Sonderfachleute hinzugezogen. Gegenwärtig werden in 60 Gremien Regelwerke und andere Empfehlungen bearbeitet.

## [Forschung](#)

Die FLL fördert die Forschung in den Bereichen Landschaftsarchitektur, Landschaftsentwicklung und **Landschaftsbau**. **Dazu engagiert sie sich bei Organisation und Koordinierung von Forschungsthemen** und fördert Dissertationen, Masterarbeiten durch finanzielle Leistungen.

## [Mitgliedschaft](#)

Die FLL benötigt eine breite Basis von Mitgliedern, die ihre Ziele unterstützen. Sollten Sie Interesse an der Arbeit der FLL und einer aktiven Mitarbeit in einem Arbeitsgremium haben, informieren wir Sie gern.

Mitglieder erhalten **30 % Rabatt** bei Broschüren (Ausnahme: MLV/MZW, Schadensfallsammlung) und 25 % bei Seminaren. Die **Gemeinnützigkeit der FLL** wird jährlich bestätigt; alle finanziellen Aufwendungen sind **steuerlich absetzbar**.

**Bitte beachten Sie unsere allgemeinen Bestellhinweise!**

## FLL – Arbeit für die Landschaft (Stand: Juni 2018, Preisänderungen vorbehalten)

Art. Nr.	<u>Bäume und Gehölze</u>	€
02 110 01	<b>Baumkontrollrichtlinien</b> , Richtlinien für Regelkontrollen zur Überprüfung der Verkehrssicherheit von Bäumen, 2010	30,00
02 313 01	<b>Baumuntersuchungsrichtlinien</b> , Richtlinien für eingehende Untersuchungen zur Überprüfung der Verkehrssicherheit von Bäumen, 2013	20,00
03 713 01	<b>Sparpaket Baumkontrollrichtlinien + Baumuntersuchungsrichtlinien</b> , 2013 <i>Sparpreis</i>	43,00
00 215 01	Empfehlungen für <b>Baumpflanzungen, Teil 1: Planung, Pflanzarbeiten, Pflege</b> , 2015	27,50
02 210 01	Empfehlungen für <b>Baumpflanzungen, Teil 2: Standortvorbereitungen für Neupflanzungen</b> , 2010	27,50
00 615 01	<b>Sparpaket</b> Empfehlungen für <b>Baumpflanzungen, Teil 1 + Teil 2</b> , 2015/2010 <i>Sparpreis</i>	44,00
02 411 01	<b>TP-BUS-Verticillium-</b> Techn. Prüfbestimm. zur Untersuchung v. Böden u. Substraten auf <i>Verticillium dahliae</i> , 2011	33,00
01 417 01	<b>ZTV-Baumpfleger</b> – Zusätzliche Technische Vertragsbedingungen und Richtlinien für Baumpfleger, 2017	35,00
	<b>Download</b> <b>ZTV Baum-StB 04</b> , ZTV und Richtlinien für Baumpflegerarbeiten im Straßenbau, 2004	16,50
01 605 01	<b>ZTV-Großbaumverpflanzung</b> , Zusätzliche Technische Vertragsbedingungen und Richtlinien für das Verpflanzen von Großbäumen und Großsträuchern, 2005	13,00
	<b>Download</b> Fachbericht zur <b>Pflege von Jungbäumen und Sträuchern</b> , 2008	11,00
04 117 01	<b>FLL-Verkehrssicherheitstage 2017 Teil 1: Bäume</b> (Tagungsband)	29,00
04 217 01	<b>FLL-Verkehrssicherheitstage 2017 Teil 2: Spielplätze/Spielgeräte</b> (Tagungsband)	20,00
04 317 01	<b>Sparpaket FLL-Verkehrssicherheitstage 2017 (Teil 1 + Teil 2)</b>	43,00
	<b>Hinweis</b> <b>FLL-Verkehrssicherheitstage 2011, 2012, 2013, 2014, 2015, 2016</b> (einzeln erhältlich)	
Art. Nr.	<u>Bauwerksbegrünung</u>	€
20 118 01	<b>Dachbegrünungsrichtlinien</b> , Richtlinien für Planung, Bau und Instandhaltung von <b>Dachbegrünungen</b> , 2018	35,00
60 102 01	Hinweise zur <b>Pflege und Wartung von begrünten Dächern</b> , 2002	11,00
20 218 01	<b>Fassadenbegrünungsrichtlinien</b> , Richtlinien für Planung, Bau und Instandhaltung von Fassadenbegrünungen, 2018	35,00
20 311 01	<b>Innenraumbegrünungsrichtlinien</b> , Richtlinien für die Planung, Ausführung und Pflege von Innenraumbegrünungen, 2011	33,00
20 513 01	Leitfaden <b>Gebäude Begrünung Energie</b> (Forschungsbericht), 2014	34,50
20 615 01	<b>Wandgebundene Begrünungen</b> (Forschungsbericht), 2015	38,50
Art. Nr.	<u>Biotoppflege/Biotopentwicklung</u>	€
30 292 01	Tagungsband: <b>Stützung u. Initiierung von Biotopen</b> durch landschaftsbauliche Maßnahmen, 1992	11,00
30 495 01	Tagungsband: <b>Biotoppflege im besiedelten Bereich</b> , 1995	11,00
Art. Nr.	<u>Gewässer/Entwässerung</u>	€
40 105 01	Empfehlungen von <b>Abdichtungssystemen für Gewässer</b> im GaLaBau, 2005 inkl. „Verfahren zur Bestimmung der <b>Rhizomfestigkeit v. Gewässerabdichtungen</b> “, 2008	30,00
40 206 01	Tagungsband: <b>Abdichtungen von Gewässern</b> und Nutzungen von Dachflächen im GaLaBau, 2006	16,50
40 305 01	Empfehlungen zur <b>Versickerung und Wasserrückhaltung</b> , 2005	27,50
40 507 01	Empfehlungen für Planung, Bau, Pflege und Betrieb von <b>Pflanzenkläranlagen</b> , 2008	27,50
41 111 01	Richtlinien für <b>Freibäder mit biologischer Wasseraufbereitung</b> (Schwimmteiche), ohne Berechnungsprogramm, 2011	33,00
41 112 01	Richtlinien für <b>Freibäder mit biologischer Wasseraufbereitung</b> (Schwimmteiche), <b>mit Berechnungsprogramm</b> , 2011	169,00
40 717 01	<b>Schwimmteichrichtlinien</b> , Richtlinien für Planung, Bau und Instandhaltung von <b>privaten Schwimm- und Badeteichen</b> , 2017	35,00
Art. Nr.	<u>Kalkulation/Abrechnung/Ökonomie</u>	€
30 113 01	<b>Kostenplanung</b> nach DIN 276 (incl. Excel-Tabellen auf CD-ROM), 2013	33,00
10 406 01	Empfehlungen für die <b>Abrechnung von Bauvorhaben</b> im GaLaBau, 2006	22,00
11 108 01	<b>Besondere Leistungen, Nebenleistungen, DIN 18915 bis DIN 18920</b> , 2008	22,00
30 218 01	<b>Musterbauvertrag</b> – Bauvertrag für Unternehmen des Garten-, Landschafts- und Sportplatzbaus zur Verwendung gegenüber privaten Auftraggebern, 2018	27,50
10 610 03	CD-ROM <b>MLV Pflege- und Instandhaltungsarbeiten + MZW</b> , 2010	235,62
30 316 03	CD-ROM <b>MLV + MZW Freianlagen</b> , 2016	235,62
Art. Nr.	<u>Schadensfälle</u>	€
10 316 01	<b>FLL-Schadensfallsammlung</b> GaLaBau 2016, (2000-2016 incl. 1.-4. Ergänzung)	165,00
10 216 01	<b>4. Ergänzung</b> zur Schadensfallsammlung GaLaBau, 2016	34,00
Art. Nr.	<u>Kompost/Dünger/Abfall</u>	€
150 316 01	Qualitätsanforderungen und <b>Anwendungsempfehlungen für organische Mulchstoffe und Komposte</b> – Garten- und Landschaftsbau, 2016	30,00
	<b>Download</b> Fachbericht für die <b>Entsorgung von Abfällen</b> im GaLaBau, 2005	11,00

Bitte beachten Sie unsere allgemeinen Bestellhinweise!

## FLL – Arbeit für die Landschaft (Stand: Juni 2018, Preisänderungen vorbehalten)

Art. Nr.	<a href="#">Pflege von Grün</a>	€
160 415 01	<b>Bewässerungsrichtlinien</b> - Richtlinien für die Planung, Installation und Instandhaltung von Bewässerungsanlagen in Vegetationsflächen, 2015	33,00
160 509 01	<b>Freiflächenmanagement</b> - Empfehlungen für die Planung, Vergabe und Durchführung von Leistungen für das Management von Freianlagen, 2009 (inkl. OK FREI, 2016)	33,00
<b>Download</b>	<b>Objektartenkatalog</b> Freianlagen (OK FREI 2016) inklusive Anlage „ <b>Übersicht zur Signaturenbibliothek - Flächeninhalte</b> “, 2016	30,00
<b>Download</b>	SK FREI <b>Signaturenbibliothek-QGIS</b> , inklusive Anlage „ <b>Übersicht zur Signaturenbibliothek - Flächeninhalte</b> “ 2016	520,00
<b>Download</b>	SK FREI <b>Signaturenbibliothek-ArcGIS</b> , inklusive Anlage „ <b>Übersicht zur Signaturenbibliothek - Flächeninhalte</b> “ 2016	520,00
160 116 01	Fachbericht „ <b>Winterdienst</b> “, 2016	22,00
160 716 01	<b>Bildqualitätskatalog</b> Freianlagen (BK FREI), 2016	115,00
160 614 01	Fachbericht Staudenverwendung im öffentlichen Grün – <b>Staudenmischpflanzungen für trockene Freiflächen</b> , 2014	27,50
160 306 01	Fachbericht: <b>Pflege historischer Gärten - Teil 1: Pflanzen u. Vegetationsflächen</b> , 2006	22,00
190 298 01	Empfehlungen zur <b>Begrünung von Problemflächen</b> , 1998 - <i>Sonderpreis</i>	10,00
Art. Nr.	<a href="#">Produktion/Gütebestimmungen</a>	€
170 104 01	Gütebestimmungen für <b>Baumschulpflanzen</b> , 2004	9,00
170 215 01	Gütebestimmungen für <b>Stauden</b> , 2015	9,00
170 514 01	Empfehlungen für <b>Begrünungen mit gebietseigenem Saatgut</b> , 2014	27,50
170 318 01	Regel - Saatgut - Mischungen Rasen, <b>RSM Rasen 2018 (Jährliches Abo möglich)</b>	17,50
170 616 01	<b>TL Fertigrasen</b> , Technische Lieferbedingungen f. Rasensoden aus Anzuchtbeständen, 2016	30,00
Art. Nr.	<a href="#">Spiel/Sport</a>	€
180 816 01	Empfehlungen für Planung, Bau und Instandhaltung von <b>Skate- und Bikeanlagen</b> , 2016	30,00
180 714 01	<b>Sportplatzpflegerichtlinien</b> – Richtlinien für die Pflege und Nutzung von Sportanlagen im Freien; Planungsgrundsätze, 2014	33,00
180 614 01	<b>Reitplatzempfehlungen</b> – Empfehlungen für Planung, Bau und Instandhaltung von Reitplätzen, 2014	27,50
180 308 01	<b>Golfplatzbaurichtlinie</b> , Richtlinie für den Bau von Golfplätzen, 2008	33,00
180 507 01	Fachbericht <b>Golfanlagen als Teil der Kulturlandschaft</b> , Planung u. Genehmigung, 2007	24,00
180 109 01	Richtlinie <b>Golfplatzbau +</b> Fachbericht <b>Golf- Kulturlandschaft</b> , <i>Doppelpack-Sparpreis</i>	48,00
Art. Nr.	<a href="#">Sonderthemen der Freiraumplanung</a>	€
211 412 01	Empfehlungen für Planung, Bau und Instandhaltung der <b>Übergangsbereiche von Freiflächen zu Gebäuden</b> , 2012	27,50
211 211 01	Fachbericht <b>Garten und Therapie</b> , 2011 <span style="float: right;"><i>Sonderpreis</i></span>	10,00
210 707 01	Fachbericht <b>Licht im Freiraum</b> , 2007	25,00
Art. Nr.	<a href="#">Wegebau/Mauerbau</a>	€
200 812 01	Empfehlungen für Planung, Bau und Instandhaltung von <b>Trockenmauern aus Naturstein</b> , 2012	27,50
201 012 01	Empfehlungen für Planung, Bau und Instandhaltung von <b>Gabionen</b> , 2012	27,50
201 112 01	Empfehlungen <b>Trockenmauern</b> und Empfehlungen <b>Gabionen</b> , <i>Doppelpack-Sparpreis</i>	44,00
<b>Download</b>	Richtlinie für die Planung, Ausführung und Unterhaltung von <b>begrünbaren Flächenbefestigungen</b> , 2008	33,00
200 507 01	Fachbericht zu Planung, Bau u. Instandhaltung von <b>Wassergebundenen Wegen</b> , 2007	22,00
201 213 01	<b>ZTV-Wegebau</b> – Zusätzliche Technische Vertragsbedingungen für den Bau von Wegen und Plätzen außerhalb von Flächen des Straßenverkehrs, 2013	25,00
Art. Nr.	<a href="#">Friedhof/Bestattung</a>	€
211 008 01	Fachbericht <b>Aktuelle Trauerkultur</b> - Begriffsbestimmungen u. religiöse Herleitung, 2008	22,00
211 118 01	Fachbericht Standards für die Durchführung von <b>Friedhofsentwicklungsplanungen</b> , 2018	27,50
<b>Download</b>	<b>MLV Friedhofsrahmenpflege</b> , 1997 (Scan)	16,50
Art. Nr.	<a href="#">Pflanzenkrankheiten/Schädlinge</a>	€
211 807 01	<b>Kiefernholznekrose</b> , Faltblatt (JKI/FLL/GALK), 2014	0,60
210 615 01	<b>Netzwanzen an Heidekrautgewächsen</b> , Faltblatt (JKI/FLL/GALK), 2015	0,60
<b>Hinweis</b>	Darüber hinaus sind <b>diverse weitere Faltblätter über den Online-Shop</b> erhältlich	0,60
Art. Nr.	<a href="#">English publications/Englische Veröffentlichungen</a>	€
<b>Download</b>	<b>Green roof guidelines</b> , 2009	33,00
<b>Hinweis</b>	Darüber hinaus sind <b>weitere englischsprachige Veröffentlichungen über den OnlineShop</b> erhältlich	

**Bitte beachten Sie unsere allgemeinen Bestellhinweise!**



## **Classification of FLL publications:**

### **Contractual documents:**

The contractual agreement between client and contractor:

- Technical Test Specifications (TP);
- Technical Delivery Conditions (TL);
- Additional Technical Terms of Contract (ZTV).

Contract documents contain contractual provisions and must be agreed in individual cases between the Principal and the Agent. ZTV supplement the General Technical Terms of Contract (ATV) and correspond in terms of type and rank to Additional Technical Terms of Contract in the sense of § 1 (2) No. 4. VOB/B. TP and TL can be referenced in other contractual terms and conditions and regulatory works.

### **Guidelines:**

Instructions for planning, construction and maintenance.

These should reflect the generally recognised code of practice. The term "generally recognised code of practice" means construction methods and designs that are confirmed in theory, used by the vast majority of practitioners and have proven themselves durable in practice.

### **Recommendations:**

Instructions for planning, construction and maintenance.

These represent the current state of technology. They should prove themselves in practice, so that the generally accepted state-of-the-art technology can be developed from them. They represent a preliminary stage to the guidelines. The term "state-of-the-art" should be understood as meaning current technical possibilities whose testing for permanence has not yet taken place in practice.

### **Technical reports:**

Instructions for planning, construction and maintenance.

Technical reports should provide information for clients, planners, executing companies and other interested parties. They can be used as a guide and manual for professional action.

### **Other informative publications**

In addition, the FLL publishes work results (e.g. research projects, events) in the form of research reports, conference proceedings, CD-ROMs and flyers.

The FLL „Green Roof Guidelines - Guidelines for the Planning, Construction and Maintenance of Green Roofs“ were developed from the „Principles for Green Roofing“ published in 1982 and have been revised several times since 1990. They are recognized as a benchmark set of guidelines for green roofs in Germany. Abroad, the FLL Green Roof Guidelines are noted with great acceptance and serve as a basis for the development of national regulations in some neighboring countries.

In a major change compared to the 2008 edition, the topic ‚Securing against material displacement on flat and pitched roofs‘ has been fundamentally revised. For the first time, the different forms of material displacement, such as surface erosion, slippage and exceeding the angle of repose are now considered separately. Corresponding safeguards against these three types of material relocations are described. In addition, topics have been supplemented that are subject to technical developments and where new issues have arisen. Turf greening has been taken up as a vegetation with its own turf substrate requirement profiles. The issue of biodiversity of green roofs is another new topic being considered, since a better protection of the flora and fauna than providing habitats on roofs will hardly be possible to achieve in urban areas. Finally, the information on the neighboring works of roof and building waterproofing has been adapted due to the extensive and fundamental changes to DIN 18195, DIN 18531, DIN 18532 and DIN 18533.

### **LandscapeDevelopment and Landscaping Research Society e.V. (FLL), [www.fll.de](http://www.fll.de)**

- Regulatory works publisher for the „Green Industry“ - Foundation 1975 - recognized charitable status

FLL sets up contract documents, guidelines, recommendations and specialist reports for the „green industry“ in about 65 interdisciplinary working committees, and continues to publish them in its own series of publications. By formulating specific requirements, FLL contributes to quality assurance in the sense of sustainability. The cooperation of about 600 professionals (scientists, representatives of municipalities, planning offices, construction companies, manufacturing companies, experts, etc.) is voluntary. The FLL is also involved in shaping future-oriented projects and actions for the „green industry“. The FLL currently has 33 professional and trade associations among its members - of which 4 are international - and is taking on a role as a discussion forum for about 33,000 members for their specialist topics in the fields of landscape architecture, landscape development and landscaping.

FLL publications are strictly product-neutral, comply with the principles of the German Institute for Standardization (DIN) and therefore enjoy a high degree of acceptance in the construction standards work. They reflect the state-of-the-art technology and should be introduced as codes of practice.

Due to the early involvement of the relevant expert groups, as well as public objection procedures, there is a rebuttable presumption for FLL publications that they are recognized codes of practice within the German Construction Contract Procedures (VOB) if they have proven themselves in practice. Numerous FLL publications and/or procedures mentioned therein become part of contracts through explicit references in the so-called Landscaping Standards (DIN 18915 to 18920). In public tendering, this happens automatically.

The contents of the FLL regulations are presented to the general public in special educational training events. Research projects are coordinated and promoted by the FLL on topics that are related to their publications. FLL publications can be ordered in the online shop at [www.fll.de/shop](http://www.fll.de/shop) as a brochure or as a download.

